



Katalog dekoracji
Decorations catalogue

AMR CAMPANIA

Legenda

Legend



Wymiary

(wys. x szer. x głęb.)
Dimensions
(height x width x depth)



Wysokość

Height



Szerokość

Width



Średnica

Diameter



Waga

Weight



Moc

Power



Punkty świetlne

Illuminating points



Ilość elementów

Elements number



Ilość sekcji (połączeń)

Sections (joints) number



Ilość sznurów

Strings number



Ilość tipsów

Tips number



Maksymalna liczba połączeń

Joints maximum number



Oświetlenie tradycyjne

Traditional lighting



Oświetlenie LED

LED light



Ilość w opakowaniu

Pcs per package



Dostępne/podstawowe kolory

Available/basic colours



Podwójna izolacja

Double isolation



Sposób/typ montażu

Type of installation



Animacja/Efekt

Animation/Effect



Element przestrzenny

Spatial element



Zastosowanie zewnętrzne

Outdoor use



Zastosowanie wewnętrzne

Indoor use



Zasilanie sieci 230V

Power network 230V



Ważna informacja

Important information

Barwa światła

Light colour



Biały/Podstawowy
White/Basic



Ciepły biały
Warm white



Żółty
Yellow



Pomarańczowy
Orange



Czerwony
Red



Różowy
Pink



Fioletowy
Violet



Niebieski
Blue



Zielony
Green



Wielokolorowy
Multicoloured

Kolor przewodu

Wire colour



Biały
White



Zielony (ciemno zielony)
Green (dark green)



Transparentny
Transparent



Nowy produkt
New product



Kod QR

(do zeskanowania odpowiednim urządzeniem, np. smartfonem)

QR Code

(scanned by appropriate device eg. smartphone)



PL Barwa światła, fotografie i wizualizacje zawarte w katalogu mogą nie odzwierciedlać w pełni rzeczywistości.

EN Light colour, pictures and visuals contained In catalogue may not fully reflect reality.

Słowa wstępu

Introduction

PL Firma AMR CAMPANIA z siedzibą w Jastrzębiu-Zdroju od kilkunastu lat prężnie działa w branży dekoracji świetlnych. Swoimi działaniami obejmuje dekorowanie miast, gmin, centrów handlowych, hoteli, agencji artystycznych i eventowych oraz wielu innych podmiotów. Swoim profesjonalnym podejściem do powierzonych zadań zdobywa zaufanie nowych klientów. Ciągły rozwój i kreatywne spojrzenie na potrzeby klienta pozwalają podejmować coraz trudniejsze zadania.

EN AMR CAMPANIA company established in Jastrzebie-Zdroj from several years is very active in the lightening decorations industry. AMR Campania is mainly focused on decorating the cities, municipalities, shopping centers, hotels also cooperates with art and event agencies. By creative projects and professional implementation, company acquires more and more trust from new customers. They enjoy and appreciate high quality and aesthetics of decoration.

Wychodząc naprzeciw prężnie rozwijającej się branży dekoracji świetlnych jesteśmy w stanie sprostać indywidualnym i nietypowym wymaganiom klientów. W ofercie znajduje się zarówno tradycyjne oświetlenie żarówkowe, jak i profesjonalne dekoracje LED. Specjalizujemy się w dekoracyjnych motywach oraz rzeźbach świetlnych.

According to rapidly developing requirements of light industry we are able to meet the individual and unusual demands of our customers. We offer both traditional incandescent lighting, as well as professional LED Decorations. We specialize in flat and spatial decorative motifs and light sculptures.

Nasza oferta obejmuje:

- ▶ dekoracje świetlne wykonane z wysokiej jakości materiałów,
- ▶ profesjonalną obsługę oraz fachową pomoc przy wyborze dekoracji,
- ▶ możliwość montażu i demontażu dekoracji,
- ▶ możliwość naprawy dekoracji,
- ▶ gwarancję na dostarczone dekoracje,
- ▶ serwis gwarancyjny w okresie eksploatacji, a także pogwarancyjny.

Our offer consists of:

- ▶ light decorations made from high quality materials,
- ▶ professional service and assistance in choosing decorations,
- ▶ possibility of assembly and disassembly decoration,
- ▶ possibility of repair decorations,
- ▶ warranty for provided decorations,
- ▶ warranty service during the exploitation, and post-warranty.

Spis treści

Contents

Referencje / References

5

Portfolio / Portfolio

9

Motywy / Motifs

17

Motywy ekonomiczne / Economic motifs 20

Śnieżynki / Snowflakes 22

Kolekcja podstawowa / Basic collection 24

Napisy / Writings 40

Kompozycje / Compositions 43

Przestrzenne / Three-dimensional 48

Rzeźby / Sculptures

55

Anioły świetlne / Light angels 56

Fontanny świetlne / Light fountains 64

Drzewa świetlne / Light trees 68

Postumenty pod rzeźby / Pedestals for sculptures 69

Materiały dekoracyjne / Decorative materials

71

Snowfall™ / Snowfall™ 72

Węże świetlne / Rope light 75

Girlanda żaróvkowa / Garland bulbs 76

Żarówki / Bulbs 77

Sople świetlne / Icicles light 78

Kurtyny świetlne / Light curtains 80

Sznury świetlne / Light strings 82

Choinki / Christmas trees 84

Girlandy / Garlands 89

Wianki / Wreaths 91

Kule / Spruce Balls 91

Ozdoby / Ornamentation 92



...realizuje
posiada bogatą ofertę

...NIA
...190 c
...Zdrój

ZIKIT
...TRANSPORTU W KRAKOWIE
...KRAKÓW, dnia 8 stycznia 2009 r.

TC
Galeria Kazimierz

Kraków, 14 maja 2009 r.

LIST REFERENCYJNY

...ze w sezonie 2008/2009 GTC Galeria Kazimierz Sp. z o.o.
...CAMPANIA przy realizacji zamówień dekoracji
...handlowego Galeria Kazimierz przy ul. Podgórskiej 54 w
...CAMPANIA składała się bardzo dobrze. Jakość dekoracji oraz
...z uwagi, a zgłoszone przez nas prośby
...zyskim, którzy





Referencje

References

Zaufało nam już wiele firm i instytucji
We have been trusted by many companies and institutions.



ZARZĄD INFRASTRUKTURY KOMUNALNEJ I TRANSPORTU W KRAKOWIE
ul. Centralna 53, 31-586 Kraków, centrala tel. +48 12 616 7000, fax: +48 12 616 7417, e-mail: sekretariat@zikit.krakow.pl

Kraków 10 lutego 2012 roku

Pan
Lech Sikora
AMR CAMPANIA

Szanowny Panie!

Znakomity wizerunek naszego Miasta jest wartością nie do przecenienia. Kraków to miejsce szczególne, pełne przepięknych miejsc i wspaniałych ludzi. Dekoracje, które dzięki Państwa hojności ozdobiły nasze Miasto, pozwoliły wszystkim poczuć magię Świąt Bożego Narodzenia. Świetliste anioły i kolorowy wystrój choinek sprawił, że Gród Kraka mogliśmy na nowo odkrywać i cieszyć się jego urokiem.

To dzięki Państwa hojności ulice, place i najważniejsze punkty miasta w okresie Świąt Bożego Narodzenia zyskały nowy blask.

Jestem niezmiernie szczęśliwa, że Kraków ma swoich sponsorów, którzy dbają o to, by królewskie Miasto było jeszcze piękniejsze.

Wierzę, że w następnych latach również będziemy mogli liczyć na Państwa przychyłność i wsparcie.

Jeszcze raz serdecznie dziękuję w imieniu swoim, mieszkańców.

Z pozdrowieniami

Jastrzębia Spółka Węglowa S.A.
14-020 Warszawa
ul. Żurawia 11
tel. +48 22 616 4111, fax: +48 22 616 3071, e-mail: jastrzebia@sw.com.pl
NO:0190-02/12
Jastrzębie-Zdrój, dn. 21.02.2012r.



REFERENCJE

Jastrzębia Spółka Węglowa S.A. zawiadamia, że AMR CAMPANIA z siedzibą w Jastrzębiu (Zdrój) przy ulicy Pacyzyńskiej 190C wykonała usługi dekoracji świetlnej pod światło Jastrzębia Spółki Węglowej w Jastrzębiu (Zdrój) w postaci aniołów świetlnych na postumencie oraz drzewa świetlne.

Usługa została zrealizowana profesjonalnie i terminowo. Wykonana dekoracja zaskarżyła uwagę ze względu na doskonały efekt wizualny, wysoką jakość i estetykę wykonania, a także funkcjonalność i trwałość użytkowania.

Jastrzębia Spółka Węglowa S.A. rekomenduje firmę AMR CAMPANIA z siedzibą w Jastrzębiu (Zdrój) przy ulicy Pacyzyńskiej 190C jako firmę godną polecenia w zakresie usług reklamowych. Firma zrealizowała w roku 2011 usługi wykonania i zamontowania szczyt z wyłuskaniem. Usługa została wykonana z należytą starannością w określonym terminie.

NR: 000072081, Sąd Rejonowy dla M. St. Warszawa, XII Rejon Sądowy, ul. Prokocimskiego 12, XII-10-2001/11-15, Kancelaria Sądowa XII Rejonu Sądowego, ul. Prokocimskiego 12, 02-230 Warszawa, tel. +48 22 628 41 41, fax: +48 22 628 41 42, e-mail: kancelaria@rsd12.sad.gov.pl

Z-ca Burmistrza Dzielnicy Żoliborz
Miasta Stołecznego Warszawy
ul. Bielskiego 6B, 01-057 Warszawa
tel. 22 628 20 20, fax 22 628 20 20
m.stowarzyszenie@zoliborz.gov.pl, www.zoliborz.gov.pl

Warszawa, 6.02.2012r.

AMR CAMPANIA
ul. Pacyzyńska 190C
04-335 Jastrzębie-Zdrój

AMR CAMPANIA zgodnie wywiązała się ze złożonym zamówieniem – wykonaniem reklamowej dekoracji centralnego miejsca Żoliborza – Placu Wilenskiego.
Firma otrzymała zlecenie zakupu, dostawy i montażu oświetlenia 5 drzew stojących na Placu. Do dekoracji Firma użyła światła świetlnych LED, po 50 sztuk w każdym na dekorację jednego drzewa. Firma zrealizowała zlecenie w całości i zgodnie z umową. Światła oświetlają z zewnątrz 5 drzew, które przypomniły „gorące krzesła” i były świetnie widoczne w zimny wieczór, natomiast atrakcyjny światłowodowy element dekoracji Dzielnicy. Urząd otrzymał licencje podświetlenia i dowody uznania od mieszkańców za tę iluminację.

ZAKŁAD ZIELONI MIEJSKIEJ
40-523 KATOWICE, ul. S. Krakowskiego 138
REGON: 000344711 | NIP: 634-005-13-570
Krajowa Izba Rozliczeniowa S.A. ul. Krakowska 2, nr 14 | 40-100 | 75 14 100 0007 0009 930

Katowice, 06.02.2012r.

AMR CAMPANIA
ul. Pacyzyńska 190c
44-335 Jastrzębie-Zdrój

LIST REFERENCYJNY

Zakład Zieloni Miejskiej Katowice zawiadamia, że AMR CAMPANIA wykonała usługi dekoracji świetlnej placu Jana Pawła II przy Auliłaterze Chrystusa Króla w Katowicach, w postaci anioła świetlnego na postumencie o łącznej wysokości 6 metrów.

Usługa została zrealizowana profesjonalnie i terminowo. Wykonana dekoracja zaskarżyła uwagę ze względu na doskonały efekt wizualny, wysoką jakość i estetykę wykonania, a także funkcjonalność i trwałość użytkowania.

Polecamy AMR CAMPANIA jako rzetelnego partnera solidnie wywiązyającego się z podjętych zobowiązań.

Zarząd Zieleni Miejskiej w Rybniku
Jednostka Budowlano-Miastobudowlana
ul. Piłsudskiego 11
44-200 Rybnik, tel. 71 42 48 48, fax 71 42 48 29
NIP: 642-660-41-08, e-mail: zieleni@rybnik.pl
Krajowa Izba Rozliczeniowa S.A. ul. Krakowska 2, nr 14 | 40-100 | 75 14 100 0007 0009 930

Rybnik, dnia 02 lutego 2012 r.

AMR CAMPANIA
ul. Pacyzyńska 190C
44-335 Jastrzębie-Zdrój

REFERENCJE

Informuję, że AMR CAMPANIA z siedzibą ul. Pacyzyńska 190C, 44-335 Jastrzębie w roku 2011 zrealizowała dla jednostki elementy dekoracji (burmistrz) świetlnej na kwocie 67 241,39 zł.

Wykonanie zamówienia całkowicie wyprzedziło sięze oczekiwania, zrealizowane było terminowo.

Ta podjęta indywidualna współpraca możemy pomóc korzystając z usług AMR CAMPANIA.

URZĄD MIEJSKI W CZECHOWICACH-DZIEDZICACH
Plac Jona Pawła II 1
43-502 Czechowice-Dziedzice

Czechowice – Dziedzice, dnia 31 stycznia 2011 r.

REFERENCJE

Urząd Miejski w Czechowicach – Dziedzicach zawiadamia, że Firma AMR CAMPANIA z siedzibą w Jastrzębiu (Zdrój) w roku 2010/11 wykonała prace wykonania i montażu aniołów świetlnych i elementów dekoracji świetlnej.

Realizacja prac wykonana była w sposób profesjonalny przy wysokiej cenowo-kosztowej cenie.

ZARZĄD INFRASTRUKTURY KOMUNALNEJ I TRANSPORTU W KRAKOWIE
ul. Ciwalska 5, 31-100 Kraków, tel.: 12 248 91 00, fax: 12 248 91 11, e-mail: sekretariat@ztk.krakow.pl

ZIKI/S1491/10/NO/16144 Kraków, dnia 25 marca 2011 r.

REFERENCJE

Zarząd Infrastruktury Komunalnej i Transportu w Krakowie zawiadza, że Agencja Marketingowo-Reklamowa **CAMPANIA** ul. Pszczyńska 190c, 44-335 Jastrzębie Zdrój wykonała następujące prace:

- „Umieszczenie wraz z serwisem: smoleńca świętych dzieł i myślicy, choinki świetlnej, fontann świetlnych oraz wykonanie dekoracji balonów.”
Prace wykonywane były w okresie od 23.12.2010 r. do 31.01.2011 r.
Wzrost spec. brutto wyniósł 1000000 zł netto.
Prace zostały wykonane z należytą starannością.
- „Dekoracja Miasta Krakowa z okazji Świąt Bożego Narodzenia i Nowego Roku z Capri 2 – iluminacja lamp.”
Prace wykonywane były w okresie od 05.12.2010 r. do 31.01.2011 r.
Wzrost spec. brutto wyniósł 1000000 zł netto.
Prace zostały wykonane z należytą starannością.
- „Dekoracja Miasta Krakowa z okazji Świąt Bożego Narodzenia i Nowego Roku z Capri 1 – dekoracja ulic.”
Prace wykonywane były w okresie od 05.12.2010 r. do 31.01.2011 r.
Wzrost spec. brutto wyniósł 1000000 zł netto.
Prace zostały wykonane z należytą starannością.

Z poważaniem
Zdzisław Wójcik
Zastępca Dyrektora

OTWARCIE
1. Adres
1. ul. 503.

BURMISTRZ MIASTA ORZESZE
43-180 Orzesze, ul. Św. Hieronima 21, tel. 032 32 488 00, fax 032 32 488 26
www.orzesze.pl, e-mail: burmistrz@orzesze.pl

Orzesze, dnia 05.02.2010 r.

REFERENCJE

Niniejszym pisemnie stwierdzam, że **AMR CAMPANIA** ul. Pszczyńska 190c, 44-335 Jastrzębie Zdrój w okresie 2009/2010 dostarczyła dekorację świetlną – instalację świetlną z pominięciem i fontann świetlnych, które zostały ustawione w Orzeszu na okres od 11.12.2009 r. do 26.01.2010 r. Należy stwierdzić, iż zostało obsługiwane klienta jak i jakość produktów nie budzi żadnych zastrzeżeń.

Wobec powyższego uważa się, że **AMR CAMPANIA** jest firmą godną polecenia.

Z poważaniem
Zdzisław Wójcik
Zastępca Dyrektora

PRZEDSIĘBIORSTWO WIELOBRZOSZE OFI
K. A. MICHAŁCZYŃSKI SPÓŁKA JAWNA
ul. Bohaterów 47, 41 – 300 Dąbrowa Górnicza
Tel: +48 32 264 90 39
Fax: +48 32 264 93 33
Dąbrowa Górnicza, dnia 28.01.2010 r.

REFERENCJE

Potwierdzamy, że **AMR CAMPANIA** z siedzibą przy ulicy Pszczyńskiej 190 c 44-335 Jastrzębie Zdrój, na rzecz Przedsiębiorstwa Wielobrozowe K.A. Michałczyński spółka jawna wykonała usługę obejmującą dostarczenie dekoracji (Bożonarodzeniowej). Zamówienie zostało wykonane z należytą starannością, zgodnie z ustalonymi warunkami i wymaganiami Zamawiającego. Zamówienie zrealizowano terminowo. Jakość świadczonych usług na bardzo wysokim poziomie i wspaniale profesjonalna obsługa klienta powoduje, że Firma **AMR CAMPANIA** jest godna polecenia.

Z poważaniem
Krzysztof Michałczyński
K.A. MICHAŁCZYŃSKI SPÓŁKA JAWNA
ul. Bohaterów 47, 41-300 Dąbrowa Górnicza
tel. 32 264 90 39, fax 32 264 93 33

Nowe Koszycy 0000100000 – oddział Regionalny Katowice – Wydział Gospodarczy Krajowego Rejestru Sądowego, ul. Limyja 1, 41-017 Katowice
NIP: 629-20-68-491
KRS: 00000-220078422

PKP ENERGETYKA

Szczecin, 2 marca 2011

REFERENCJE

W 2010 roku PKP Energetyka S.A. Zakład Pomocny zrealizowała w **AMR CAMPANIA** ul. Pszczyńska 190c 44-335 Jastrzębie-Zdrój zamówienie na zakup dekoracji bożonarodzeniowych w sezonie 2010/2011:

- posiada umowę ze dostawcą 1 szt.
- posiada umowę 21 szt.
- posiada faktury 2 szt.
- posiada na faktury 30 1 szt.
- o łącznej wartości 1000000 zł netto

Dostawy realizowane były terminowo zgodnie ze złożonymi przez nas zamówieniami. Należy zwrócić uwagę na jakość i terminowość wykonania oraz fachowość pracowników usłuszy, że **AMR CAMPANIA** jest godną polecenia.

Z poważaniem
Zdzisław Wójcik
Zastępca Dyrektora

PKP ENERGETYKA S.A.
ul. Ciwalska 5, 31-100 Kraków
NIP: 629-20-68-491
KRS: 00000-220078422

BURMISTRZ MIASTA JEDRZEJOWA
28-200 Jedrzeń Wielki, ul. 11 Lipnia 13 A, tel. 91 670 02 92
TELEFON 91 411 06 10-16 FAX 91 411 06 12 67

Jedrzeń Wielki, dnia 02.02.2010 r.

REFERENCJE

AMR CAMPANIA ul. Pszczyńska 190c, 44-335 Jastrzębie Zdrój wykonała dla gminy Jedrzeń Wielki dekorację świetlną w formie fontanny. Dekoracja dostarczono i zamontowano w miesiącu grudniu 2009 roku. Firma wykazała się ze swoich zobowiązań umownych i terminowo.

Biorąc pod uwagę jakość i terminowość wykonania oraz fachowość pracowników uważamy, że **AMR CAMPANIA** jest godną polecenia.

Z poważaniem
Zdzisław Wójcik
Zastępca Dyrektora

Urząd Gminy Pawłowice

Pawłowice, dnia 10 lutego 2009 r.

REFERENCJE

Urzędnicy w Pawłowicach potwierdzają, iż firma „Amr Campania” wykonała zlecenie zgodnie z zawartą umową, na wartości 100000 zł. Zakam umowy obejmował dostarczenie elementów świetlnych w ilości 25 sztuk na czas ustalony od dnia 01.12.2008 r. – 30.01.2009 r.

Współpracę z Firmą uważamy za pełną satysfakcjonującą, a usługi świadczone były na wysokim poziomie. Biorąc pod uwagę powyższe dochodzimy do wniosku i wspaniale dziękujemy firmie „Amr Campania” za miłą współpracę i jako godną polecenia.

Z poważaniem
Zdzisław Wójcik
Zastępca Dyrektora

Urząd Gminy Pawłowice, ul. Żołnierska 90, 41-250 Pawłowice
tel. 032 476 300, fax 032 476 300
www.amrcampania.pl, www.gminapawlowice.pl

Dom Pomocy Społecznej dla Dzieci
Zgromadzenie Siostry Benedyktynki Mijosińskiej

19-380 Elka, ul. Kłobuckiego 2, tel: (87) 615 26 35, fax: (87) 621 34 74, e-mail: lbm@elka.pl, www.zgromadzenie-elka.pl

Elka, 07 kwietnia 2009 r.

AMR CAMPANIA
ul. Pszczyńska 190c
44-335 Jastrzębie Zdrój

W imieniu „Łęczyckiego Domu” Domu Pomocy Społecznej dla Dzieci prowadzonego przez Zgromadzenie Siostry Benedyktynki Mijosińskiej w Elku zawiadamiam, iż firma **AMR CAMPANIA** dostarczyła nam komplet dekoracji bożonarodzeniowych złożony z dwóch elementów dekoracyjnych oświetlenia budowlanego oraz girland świetlnych.

Pracownicy firmy byli bardzo kompetentni i pomogli na etapie przygotowania dekoracji, wyboru oświetleniowych elementów i realizacji zamówienia. Zakupowe przez nas produkty są bardzo dobre jakościowo, trwałe i piękne. Zdecydowanie polecamy firmie **AMR CAMPANIA**.

Z poważaniem
Zdzisław Wójcik
Zastępca Dyrektora

GTTC
Galeria Kazimierz

Kraków, 14 maja 2009 r.

AMR CAMPANIA
ul. Pszczyńska 190c
44-335 Jastrzębie Zdrój

LIST REFERENCYJNY

Niniejszym informujemy, że w sezonie 2008/2009 GTTC Galeria Kazimierz Sp. z o.o. współpracowała z firmą **AMR CAMPANIA** przy realizacji zewnętrznych dekoracji bożonarodzeniowych dla centrum handlowego Galeria Kazimierz przy ul. Podgórnej 34 w Krakowie.

Współpraca z **AMR CAMPANIA** odbywała się bardzo dobrze. Jakość dekoracji oraz sposób ich montażu przetrwał bez zarzeka.

Wszystkim nam wszystkim przejmowało być z uwagi, iż zgłaszani przez nas problemy szybko rozwiązywane.

Galeria Kazimierz wkomendowała usługi firmy **AMR CAMPANIA** wszystkim, którzy chcą profesjonalnie, rzetelnie, a także wyciłażać swoim posiadaczom usług.

Niniejsze referencje zostały wykonane na prośbę **AMR CAMPANIA**.

Z poważaniem
Anna Malinowska
Główna Dyrektorka

GTTC Galeria Kazimierz Sp. z o.o., ul. Wajpasa 6, 32-078 Nowosionów, T. +48 22 80 80 700, F. +48 22 80 80 610
ul. Wajpasa 6, 32-078 Nowosionów, T. +48 22 80 80 700, F. +48 22 80 80 610
NIP: 525-20-68-491, KRS: 00000-220078422

amper
Przedsiębiorstwo Handlowe "AMPER" Sp. J.

31-800 Nowy Sącz
ul. Kłobucka 1A
NIP: 525-20-68-491
KRS: 00000-220078422

Nowy Sącz, dnia 16.03.2009 r.

REFERENCJE

Przedsiębiorstwo **AMR CAMPANIA** reprezentowanym przez pana Lecha Sikora 44-335 Jastrzębie Zdrój ul. Pszczyńska 190c dostarczyło nam w sezonie 2008/2009 dekorację i iluminację bożonarodzeniową. Produkty dostarczane były wspaniale jakościowo. Jakość wykonanych dekoracji wraz z pełną obsługą usłuszy nam bardzo. Jedną z godną polecenia firmą w naszym regionie.

Z poważaniem
Zdzisław Wójcik
Zastępca Dyrektora

Przedsiębiorstwo Handlowe "AMPER" Sp. J.
ul. Kłobucka 1A, 31-800 Nowy Sącz
NIP: 525-20-68-491
KRS: 00000-220078422





Portfolio

Portfolio

Wybrane realizacje wykonane na przestrzeni wielu lat doświadczenia w branży
Selected projects carried over many years of experience in the industry





Snowfall i sope świetlne, Ratusz w Nowym Sączu
Snowfall and light icicles, City hall, Nowy Sącz



Sanktuarium bł. Jana Pawła II, Łagiewniki w Krakowie
Sanctuary of the Holy Father John Paul II, Cracow – Lagiewniki



Fontanna świetlna, Rynek w Nowym Sączu
Light fountain, Market square, Nowy Sącz



Snowfall, Brama Floriańska w Krakowie
Snowfall, St. Florian's Gate in Cracow



Dekoracja budynku firmy Instalbud, Inowrocław
Istalbud's head office decoration, Inowrocław



Choinka stożkowa, Jastrzębie-Zdrój
Conical Tree, Jastrzebie-Zdroj



Dekoracje słupowe, Bukowina Tatrzańska
Pole decoration, Bukowina Tatrzańska



Kompleksowa dekoracja świetlna, Hotel Bukovina
Complex outdoor decoration, Bukovina Hotel



Mały aniołek przy choince, Kraków
Little Angel beside the Christmas tree, Cracow



Anioł grający na harfie, Katedra Chrystusa Króla w Katowicach
Angel playing the harp, Christ the King's Cathedral, Katowice



Rzeźby świetlne, Biurowiec JSW SA w Jastrzębiu-Zdroju
Light sculptures, JWS SA Office, Jastrzebie-Zdroj



*Anioł świetlny, Kraków
Light angel, Cracow*



*Podświetlenie fontanny Chopina, Kraków
Winter backlight of Chopin's fountain, Cracow*



*Kolorowe choinki, Czechowice-Dziedzice
Christmas trees, Czechowice-Dziedzice*



*Dekoracja budynku firmy Eurofirany, Żywiec
Eurofirany head office decoration, Żywiec*



*Dekoracje linowe, ul. Floriańska w Krakowie
Floriańska St. Christmas decoration, Cracow*



Fontanna świetlna, Bukowina Tatrzańska
Light fountain, Bukowina Tatrzańska



Fontanna świetlna, Czechowice-Dziedzice
Light fountain, Czechowice-Dziedzice



Grupa aniołów, Kraków
Angel's World, Cracow



Drzewo świetlne, Salon Mercedes w Sosnowcu
Light tree, Mercedes-Benz, Sosnowiec



Życzenia świetlne, Urząd Wojewódzki w Katowicach
Christmas wishes, Regional Office, Katowice



*Gigantyczna fontanna, Kraków
Giant fountain, Cracow*



*Motywy słupowe, Jastrzębie-Zdrój
Pole motifs, Jastrzebie-Zdroj*



*Dekoracja na ulicy Grodzkiej, Kraków
Grodzka St. decoration, Cracow*



*Drzewo przy zajezdni, Woszczyce
Tree Inn, Woszczyce*



*Dekoracja latarni, PKP Energetyka
Decoration of lantern, PKP Energetyka*



*Dekoracja budynku firmy Blach Stal, Bochnia
Decoration of Blach Stal building, Bochnia*



Anioł z harfą, Rynek w Rybniku
Angel with harp, Market square, Rybnik



Anioły świetlne przy kościele, Chmielów
Angels, Chmielów



Skrzypek pod oknem papieskim, Kraków
Violinist beneath the papal window, Cracow



Anioł grający na trąbce, Galeria MOYA w Jastrzębiu-Zdroju
Angel playing the trumpet, Shopping center MOYA, Jastrzębie-Zdroj

Więcej realizacji
More projects



<http://dekoracje.campania.pl/qr/galeria>





Motywy *Motifs*

*Kolekcja motywów świetlnych spłaskich i przestrzennych na słupy, ściany oraz uliczne przewieszki.
Collection of 2D and 3D christmas motifs for house fronts, street lamps and street decorations.*



Motywy świetlne

Light motifs

PL Motywy świetlne są idealnym rozwiązaniem do dekoracji słupów oświetleniowych, ścian budynków i jako przewieszki linowe nad ulice. Dekoracje wykonujemy z najlepszej jakości materiałów, dzięki czemu możemy zagwarantować ich trwałość.

EN Christmas motifs are perfect decorating solution for streets, street lamps and house fronts. They are made with high-quality materials with guaranteed durability.



Projekty indywidualne

Customized designs

PL Jeżeli nie znaleźliście Państwo interesującej Was dekoracji... nic straconego! Wykonujemy:

- ▶ dekoracje według Państwa projektu
- ▶ dekorację według naszego indywidualnego projektu
- ▶ zmianę kolorystyki w oferowanych motywach
- ▶ zmianę wymiarów w oferowanych motywach

EN If You haven't found the product you are looking for... don't worry! We provide:

- ▶ decorations based on your designs
- ▶ decorations of our design based on your ideas
- ▶ adjustments in colours of offered motifs
- ▶ adjustments in size of offered motifs

Wypełnienie matą dekoracyjną

Garland net filling

PL Na specjalne zamówienie, wypełniamy wybrane motywy świetlne matą dekoracyjną.

EN On special order we fill chosen decorative motifs with garland net.

Charakterystyka motywów

Motifs characteristics

PL Każdy motyw świetlny wykonany jest na konstrukcji aluminiowej i zawiera dodatkowo:

- ▶ uchwyty do mocowania (rodzaj ustalany indywidualnie)
- ▶ hermetyczną puszkę elektryczną (za wyjątkiem prostych motywów)
- ▶ przewód zasilający (zakończenie ustalane indywidualnie)

EN Every christmas motif is an aluminium construction with following elements:

- ▶ mountings (individually customized)
- ▶ hermetic electrical box (with exception of simple motifs)
- ▶ power cord

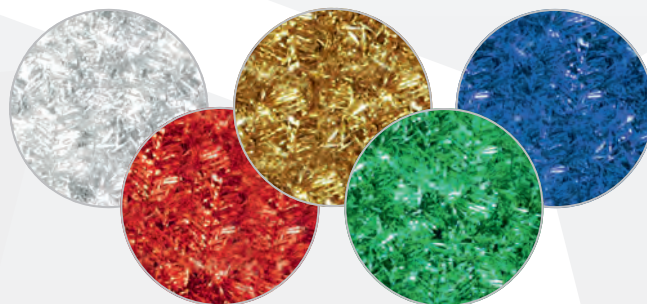

LED

Technologia LED LED technology

PL Dekoracje standardowo wykonujemy w technologii światła LED:

- ▶ znacznie obniżony pobór energii elektrycznej
- ▶ przyjazna dla środowiska
- ▶ długa żywotność (nawet do 100 000 godzin)
- ▶ bardzo mała emisja ciepła
- ▶ szeroka gama kolorystyczna

EN Our standard offer are decorations made in LED technology:

- ▶ characterised by significantly low power consumption
- ▶ eco-friendly
- ▶ high durability (even to 100 000 hours)
- ▶ low heat emission
- ▶ wide colouristic scale



Oświetlenie tradycyjne Traditional illumination

PL Oferujemy również wykonanie dekoracji w technologii światła tradycyjnego (żarówkowego).

- ▶ tańsza dekoracja
- ▶ wysokie koszty eksploatacyjne
- ▶ duża emisja ciepła
- ▶ żywotność do 1000 godzin

EN We also offer decorations made in traditional technology (with use of light bulbs).

- ▶ economic, low-budget choice
- ▶ higher exploitation choice
- ▶ high heat emission
- ▶ durability up to 1000 hours

Akcesoria montażowe

Montage accessories

Montaż na słupie

Mounting on poles





Montaż na linie

Mounting on steel wire ropes





Rodzaje mocowań Types of mountings

PL Oferujemy następujące rodzaje mocowania naszych motywów, przystosowane do Państwa wymagań:

- ▶ mocowanie słupowe  **MS**
- ▶ mocowanie elewacyjne  **ME**
- ▶ mocowanie linowe (podwieszane)  **ML**

EN We offer wide range of different types of mountings adjusted to your needs:

- ▶ mounting on poles  **MS**
- ▶ house front mountings  **ME**
- ▶ mounting on ropes (hanging)  **ML**

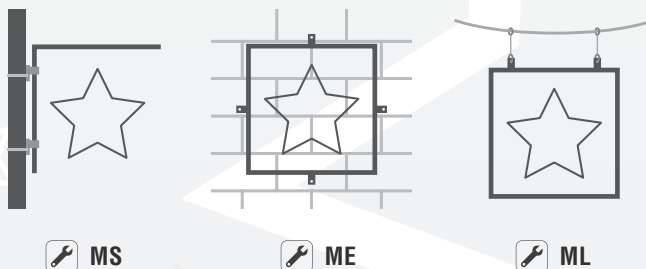

PL Rodzaj mocowania należy ustalić podczas składania zamówienia!

EN Please chose type of mounting during making an order!

Motywy ekonomiczne

Economic motifs

PL Dekoracja nie musi być droga! Wychodząc na przeciw oczekiwaniom naszych klientów, przygotowaliśmy ekonomiczną kolekcję motywów!

EN Decorations doesn't have to be expensive! To meet the expectations of our customers, we have created a collection of economic motifs!



NEW



S114

1

~ 1,10 x 1,10 m

~ 12 W

MS ME ML

S012

1

~ 1,00 x 0,90 m

~ 18 W

MS ME ML

S100

1

~ 1,05 x 1,05 m

~ 21 W

MS ME ML

S033

1

~ 0,70 x 0,70 m

~ 15 W

MS ME ML



S032

1

~ 0,70 x 0,70 m

~ 15 W

MS ME ML



S005

1

~ 0,80 x 0,80 m

~ 15 W

MS ME ML

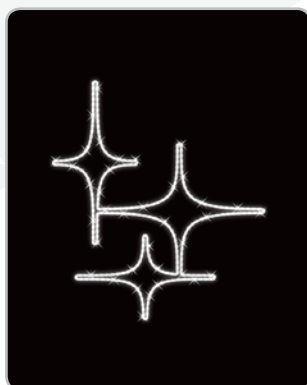

S102

1

~ 1,30 x 1,15 m

~ 21 W

MS ME ML



S034

1

~ 0,70 x 0,70 m

~ 18 W

MS ME ML



NEW



S138 1

~ 1,50 x 0,80 m

~ 12 W

●

MS ME ML

NEW

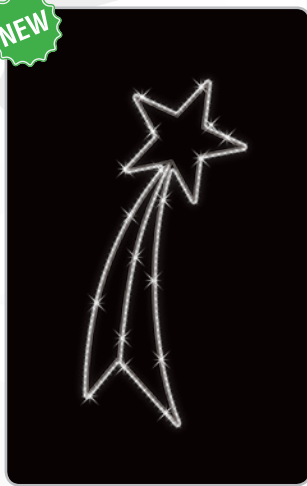

S132 1

~ 1,60 x 0,80 m

~ 18 W

○

MS ME ML



S004 1

~ 0,90 x 0,80 m

~ 21 W

●

MS ME ML



S141 1

~ 1,10 x 0,70 m

~ 21 W

○

MS ME ML



S142 1

~ 1,10 x 0,70 m

~ 21 W

○

MS ME ML

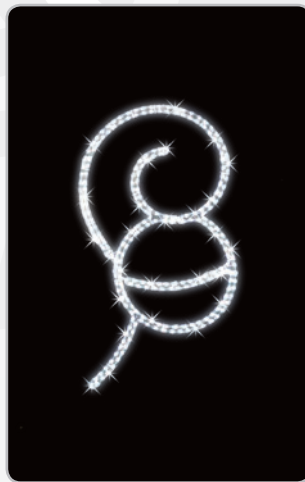

S143 1

~ 1,10 x 0,70 m

~ 21 W

○

MS ME ML

S141-1 1

~ 0,70 x 0,50 m

~ 12 W

○

MS ME ML

S142-1 1

~ 0,70 x 0,50 m

~ 12 W

○

MS ME ML

S143-1 1

~ 0,70 x 0,50 m

~ 12 W

○

MS ME ML

Śnieżynki

Snowflakes



	S001 1	S001-1 2	S001-2 1
	~ 1,10 x 1,00 m	~ 1,95 x 1,70 m	~ 1,55 x 1,35 m
	~ 36 W	~ 84 W	~ 57 W
	○	○	○
	MS ME ML	ME ML	MS ME ML

NEW



	S002 1	S002-1 1	S002-2 1
	~ 0,80 x 0,75 m	~ 1,30 x 1,15 m	~ 1,65 x 1,50 m
	~ 21 W	~ 39 W	~ 54 W
	○	○	○
	MS ME ML	MS ME ML	MS ME ML

NEW



	S003 1	S003-1 1	S003-2 2
	~ 1,00 x 0,90 m	~ 0,80 x 0,70 m	~ 1,85 x 1,65 m
	~ 27 W	~ 21 W	~ 66 W
	○	○	○
	MS ME ML	MS ME ML	ME ML



	S006 1	S006-1 2	S006-2 1
	~ 1,05 x 1,05 m	~ 2,00 x 2,00 m	~ 1,45 x 1,45 m
	~ 36 W	~ 90 W	~ 54 W
	○	○	○
	MS ME ML	ME ML	MS ME ML



	S009 1..	S009-1 1..	S009-2 2..
	~ 0,90 x 0,90 m	~ 1,55 x 1,55 m	~ 2,00 x 2,00 m
	~ 30 W	~ 69 W	~ 96 W
	○	○	○
	MS ME ML	MS ME ML	ME ML



	S011 1..	S011-1 1..	S011-2 1..
	~ 0,95 x 0,85 m	~ 1,30 x 1,20 m	~ 1,80 x 1,65 m
	~ 36 W	~ 51 W	~ 72 W
	○	○	○
	MS ME ML	MS ME ML	MS ME ML



	S105 1..	S105-1 1..	S105-2 1..
	~ 1,00 x 1,00 m	~ 0,65 x 0,65 m	~ 1,55 x 1,55 m
	~ 30 W	~ 18 W	~ 54 W
	○	○	○
	MS ME ML	MS ME ML	MS ME ML



	S120 1..	S120-1 1..	S120-2 1..
	~ 1,35 x 1,35 m	~ 1,05 x 1,05 m	~ 1,80 x 1,80 m
	~ 24 W	~ 18 W	~ 63 W
	○	○	○
	MS ME ML	MS ME ML	ME ML

Kolekcja podstawowa

Basic collection

NEW



S137

1



~ 1,30 x 1,20 m



~ 50 W



○ | ●



MS ME ML



S007

1



~ 1,05 x 1,00 m



~ 27 W



●



MS ME ML

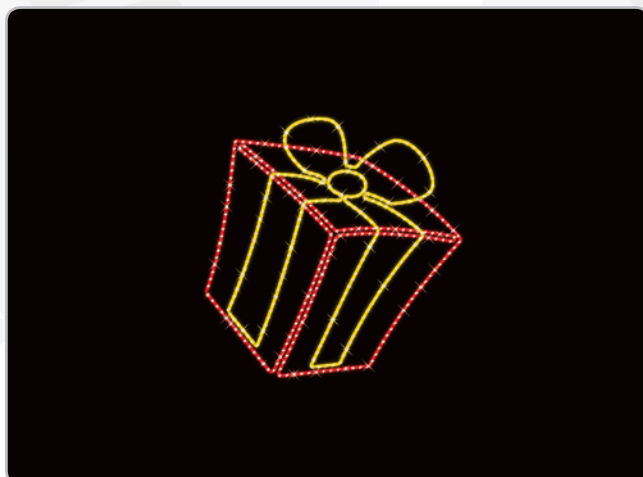

S008

1



~ 0,80 x 0,80 m



~ 27 W



● ●



MS ME ML



NEW



S133

1



~ 1,15 x 1,25 m



~ 33 W



● ●



MS ME ML



S111

1



~ 1,25 x 1,55 m



~ 60 W



● ●



MS ME ML

NEW



S139

1



~ 1,30 x 1,15 m



~ 48 W



●



MS ME ML

NEW



S160

1



~ 1,20 x 1,15 m



~ 18 W



●



MS ME ML

NEW



S170

1

~ 1,70 x 1,00 m

~ 36 W

● ○

MS ME ML



NEW



S173

1

~ 1,65 x 0,90 m

~ 38 W

● ○

MS ME ML



NEW



S171

1

~ 1,65 x 0,85 m

~ 29 W

● ○

MS ME ML



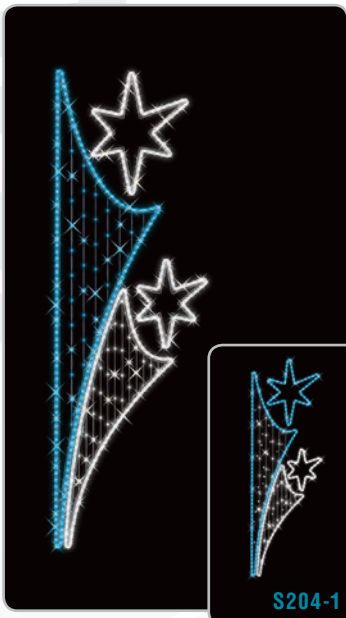

S204 1

~ 2,10 x 0,70 m

~ 47 W

MS ME ML

S204-1 1

~ 1,55 x 0,55 m

~ 31 W

MS ME ML



S200 2

~ 2,80 x 1,10 m

~ 78 W

MS ME ML



S202 2

~ 2,60 x 1,05 m

~ 77 W

MS ME ML



S203 2

~ 2,80 x 1,15 m

~ 84 W

MS ME ML

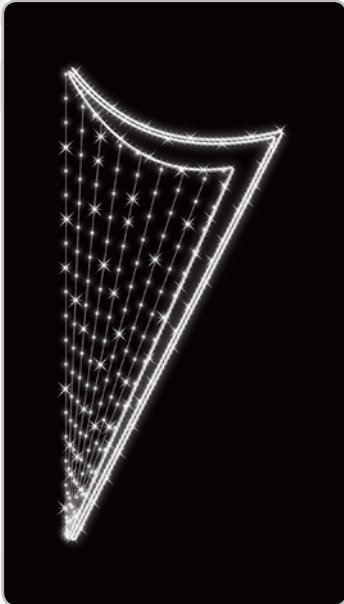

S208 1

~ 2,50 x 1,15 m

~ 58 W

MS ME ML

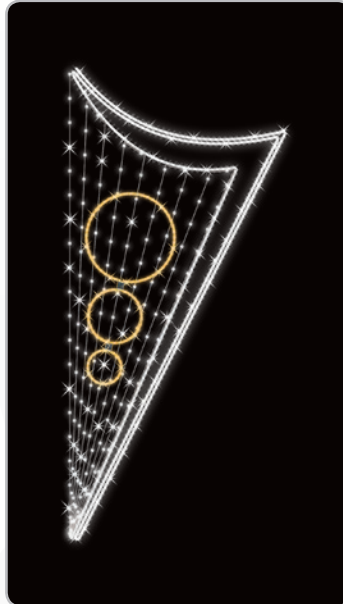

S210 1

~ 2,50 x 1,15 m

~ 67 W

MS ME ML



S209 1

~ 2,50 x 1,15 m

~ 64 W

MS ME ML

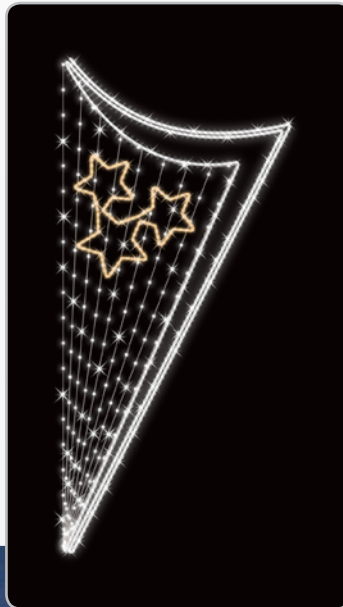

S211 1

~ 2,50 x 1,15 m

~ 67 W

MS ME ML

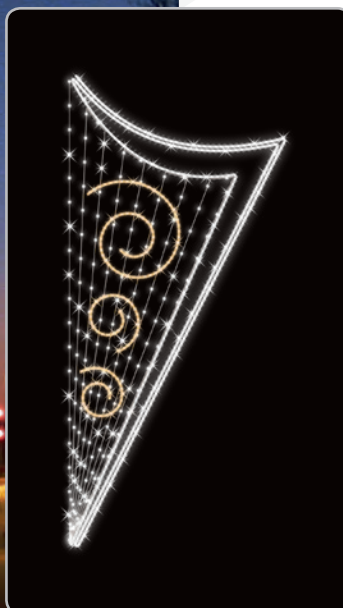

S212 1

~ 2,50 x 1,15 m

~ 70 W

MS ME ML



S131 1

~ 1,45 x 0,75 m

~ 24 W

●

MS ME ML

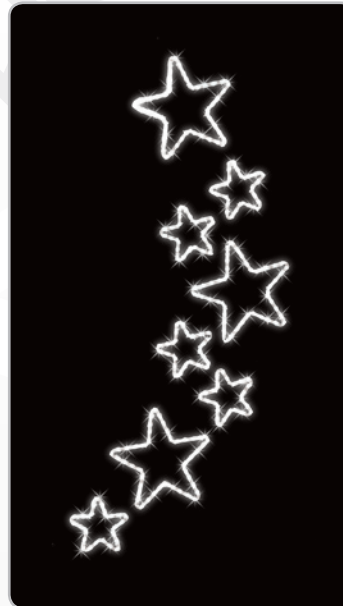

S109 1

~ 1,80 x 0,90 m

~ 24 W

○

MS ME ML



S103 1

~ 1,45 x 0,60 m

~ 24 W

● ●

MS ME ML

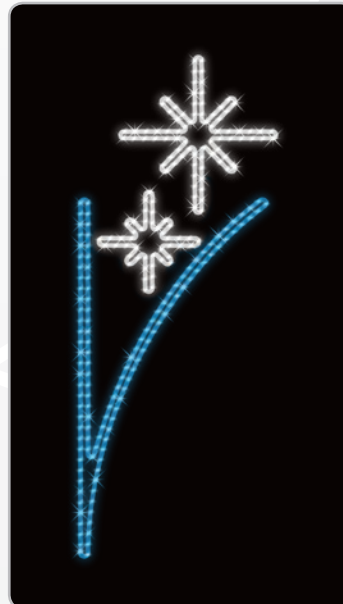

S107 1

~ 1,45 x 0,60 m

~ 24 W

○ ●

MS ME ML

S103-1 1

~ 2,05 x 0,90 m

~ 36 W

● ●

MS ME ML

S107-1 1

~ 2,05 x 0,90 m

~ 36 W

○ ●

MS ME ML



S112 1

~ 1,50 x 0,70 m

~ 18 W

●

MS ME ML



S106 1

~ 1,60 x 0,70 m

~ 27 W

●

MS ME ML

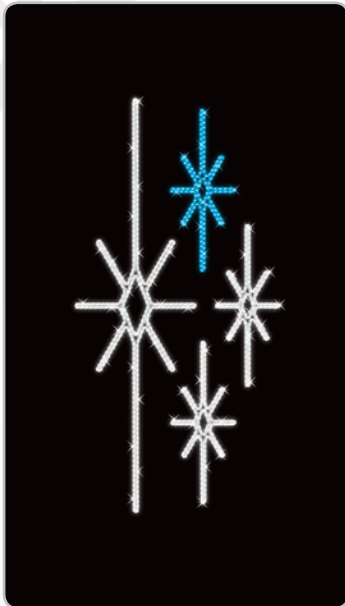

S201 1

~ 2,35 x 1,20 m

~ 63 W

MS ME ML

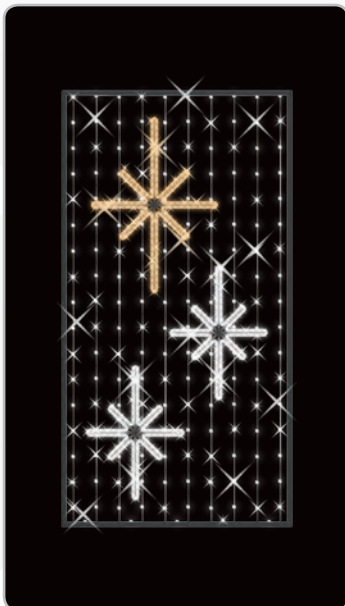

S117 1

~ 1,90 x 1,00 m

~ 58 W

MS ME ML

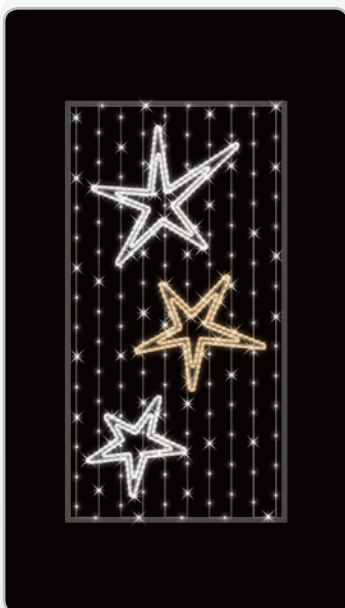

S118 1

~ 1,90 x 1,00 m

~ 64 W

MS ME ML

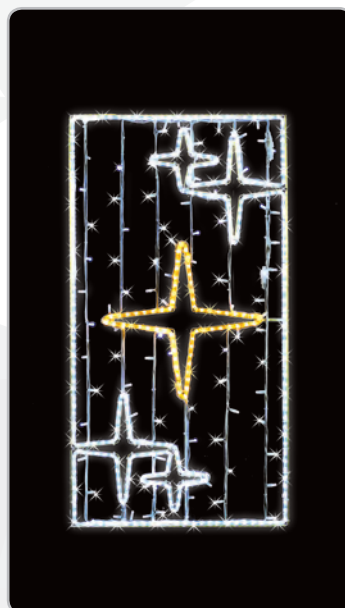

S108 1

~ 1,45 x 0,80 m

~ 51 W

MS ME ML

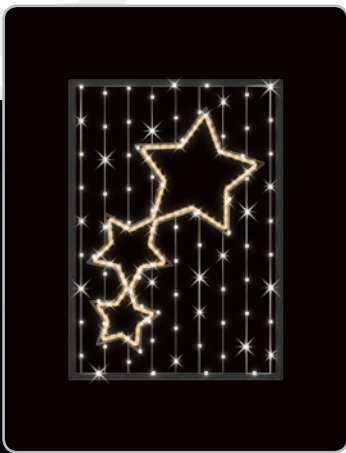

S129 1..

~ 1,00 x 0,75 m

~ 23 W

○ | ○

MS ME ML



S126 1..

~ 1,05 x 1,05 m

~ 45 W

○ | ○

MS ME ML

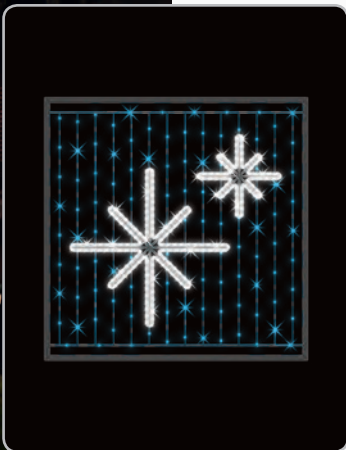

S127 1..

~ 1,05 x 1,05 m

~ 39 W

○ | ●

MS ME ML



S128 1..

~ 1,05 x 1,05 m

~ 36 W

○ | ● | ○

MS ME ML



S150 1..

~ 1,15 x 0,60 m

~ 18 W

● | ●

MS ME ML



S151 1..

~ 1,30 x 0,80 m

~ 30 W

○ | ● | ●

MS ME ML



S152 1..

~ 1,20 x 0,80 m

~ 27 W

● | ●

MS ME ML



S153 1..

~ 0,90 x 0,70 m

~ 15 W

○

MS ME ML

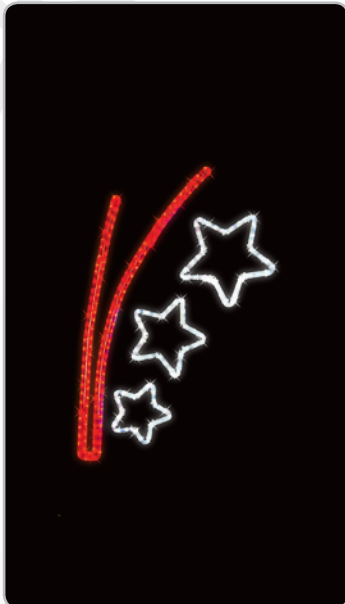

S116 1

~ 1,00 x 0,70 m

~ 21 W

MS ME ML

NEW

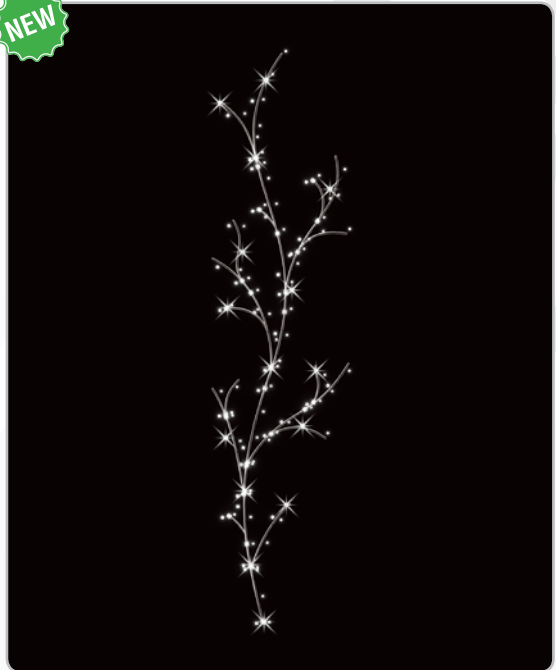

S145 1	S145-1 1
~ 1,70 x 0,45 m	~ 2,50 x 0,65 m
~ 14 W	~ 21 W
<input type="checkbox"/>	<input type="checkbox"/>
MS ME ML	MS ME ML



S207 1

~ 2,00 x 1,05 m

~ 42 W

MS ME ML

S207-1 1

~ 1,50 x 1,00 m

~ 33 W

MS ME ML



S119 1

~ 1,45 x 1,40 m

~ 45 W

MS ME ML

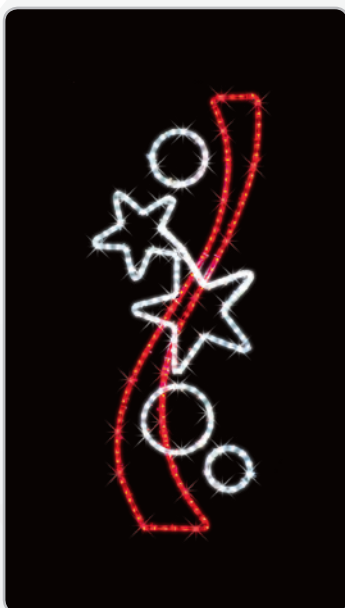

S110 1

~ 1,30 x 0,60 m

~ 21 W

MS ME ML

NEW



S155

1



~ 2,00 x 1,55 m



~ 27 W



○



MS

Średnica maksymalna: 0,70 m
Maximum diameter: 0,70 m



NEW



S156

1



~ 1,95 x 1,20 m



~ 18 W



○



MS

Średnica maksymalna: 0,70 m
Maximum diameter: 0,70 m



NEW



S157

1



~ 1,85 x 0,90 m



~ 18 W



○



MS

Średnica maksymalna: 0,70 m
Maximum diameter: 0,70 m



PL Składając zamówienie na motywy ze strony 33 należy podać specyfikację latarni w celu dostosowania mocowania.

EN When placing an order for motifs from page 33, please add specification of the lamp to adjust mountings.

NEW



S136 1

~ 1,55 x 0,95 m

~ 27 W

MS ME ML



S123 1

~ 1,25 x 1,15 m

~ 52 W

MS ME ML



S101 1

~ 1,85 x 1,10 m

~ 51 W

MS ME ML



S216 1

~ 2,10 x 1,05 m

~ 60 W

MS ME ML

S216-1 2

~ 3,50 x 1,70 m

~ 111 W

MS ME ML





NEW



S013 1

~ 1,00 x 0,90 m

~ 15 W

MS ME ML

NEW



E100 1

~ 0,95 x 1,55 m

~ 30 W

ME ML

NEW



E402 3

~ 1,00 x 4,00 m

~ 110 W

ME ML

NEW

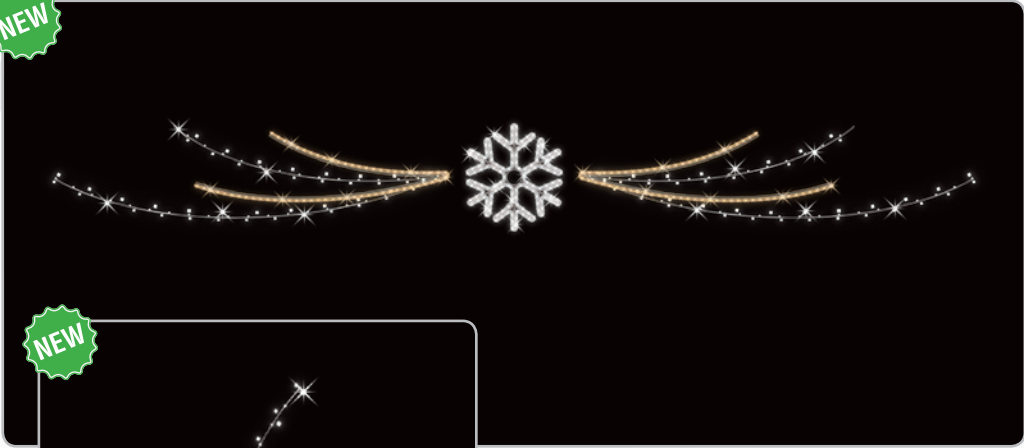

E305

3

~ 0,50 x 3,70 m

~ 38 W

○ ● ○

ME ML

NEW



S144

1

S144-1

1

~ 1,60 x 0,55 m

~ 2,55 x 0,85 m

~ 13 W

~ 23 W

● ○

● ○

MS ME ML

MS ME ML

E310

3

~ 0,80 x 4,00 m

~ 66 W

○ ●

ME ML

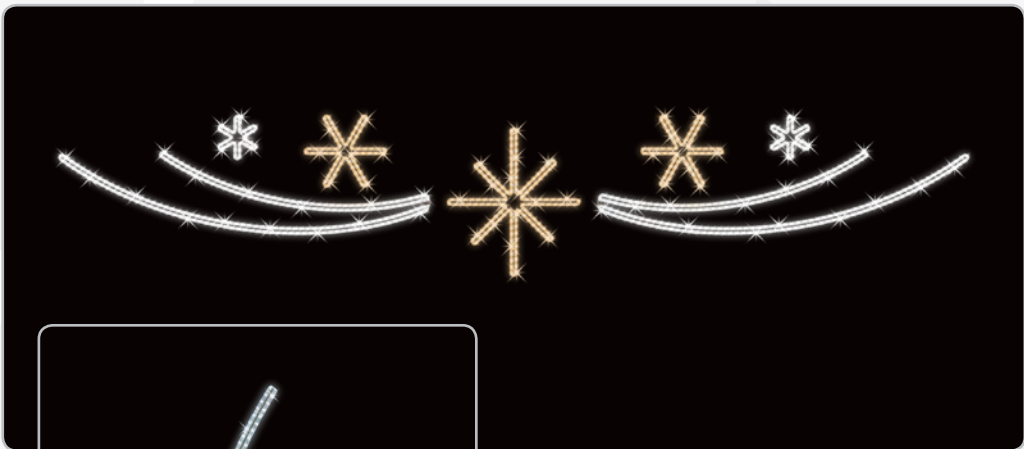

S125

1

~ 0,60 x 1,70 m

~ 24 W

○ ●

ME ML



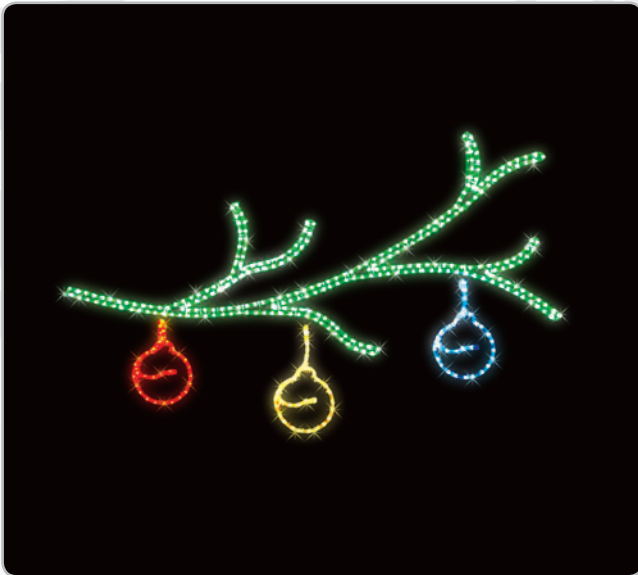

E101 1..

~ 1,00 x 1,70 m

~ 33 W

● ● ● ●

ME ML

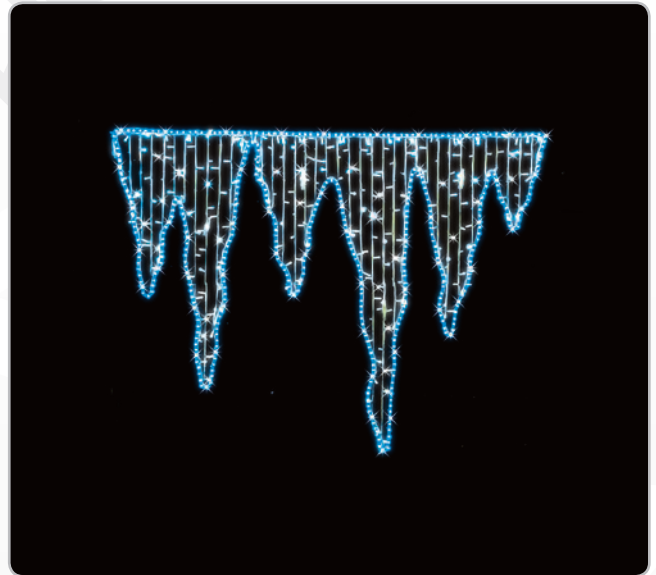

E201 1..

~ 1,50 x 2,05 m

~ 71 W

● ●

ME ML



E200 2..

~ 3,05 x 2,45 m

~ 126 W

● ●

ME

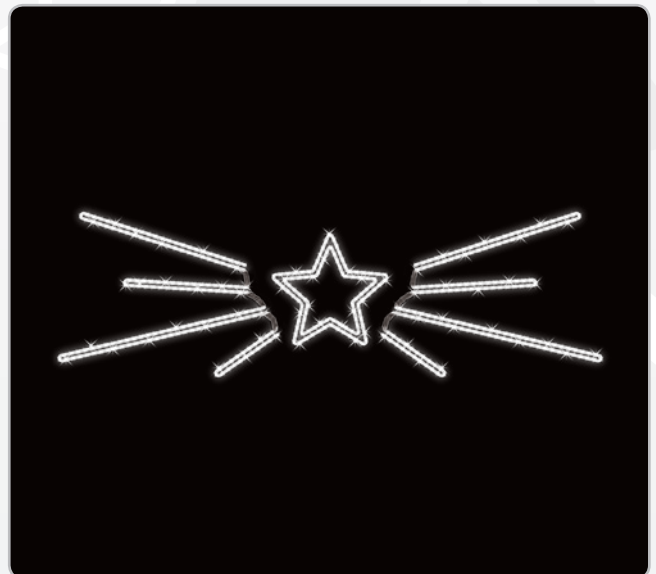

E202 1..

~ 0,70 x 2,20 m

~ 39 W

●

ME ML

NEW



NEW



S213 1

~ 2,65 x 1,10 m

~ 66 W

MS ME ML

E503 3

~ 1,05 x 5,65 m

~ 165 W

ME ML

E410 3

~ 1,10 x 4,20 m

~ 102 W

ME ML

E411 3

~ 1,10 x 4,20 m

~ 99 W

ME ML

NEW



E400 3

~ 1,10 x 4,60 m

~ 72 W

ME ML

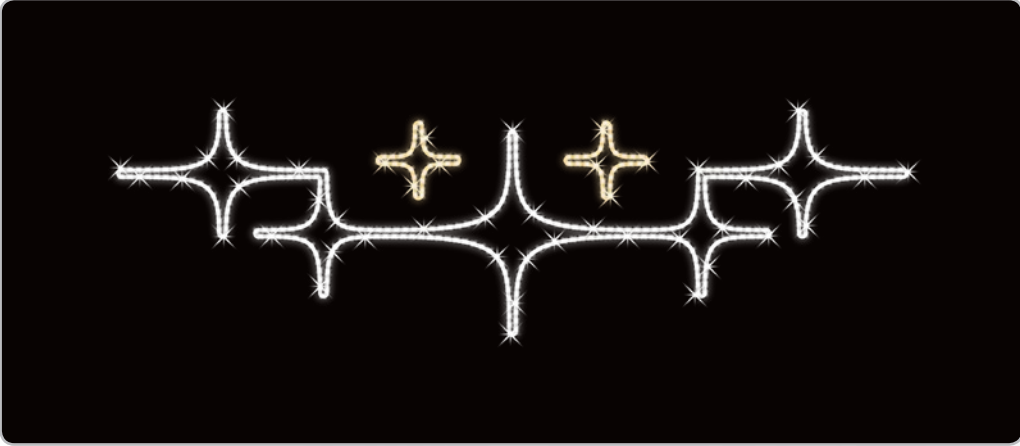

E203 1

~ 0,80 x 2,60 m

~ 33 W

ME ML

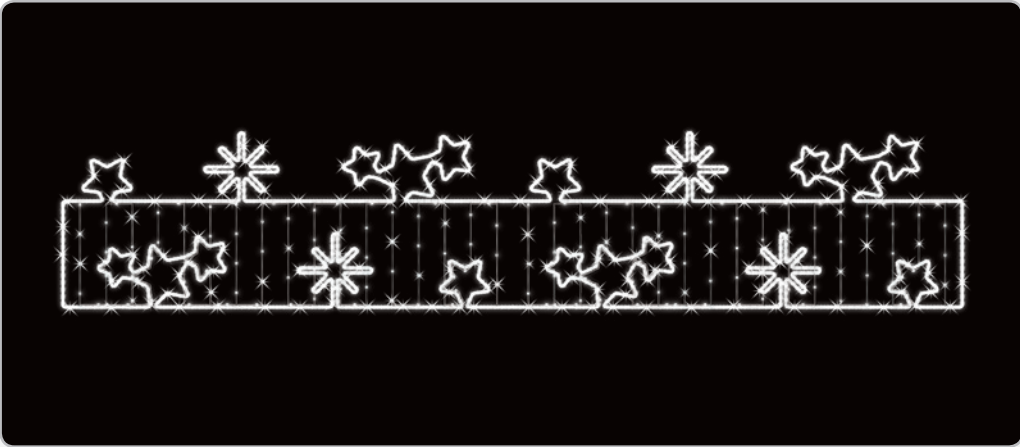

E350 2

~ 0,75 x 3,65 m

~ 100 W

ME ML

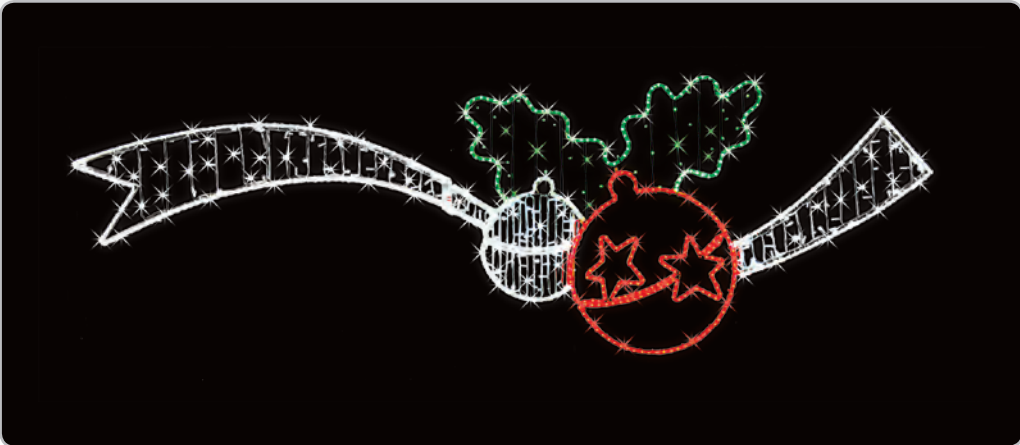

E300 2

~ 1,15 x 3,40 m

~ 76 W

ME ML

NEW



E390 3

~ 1,00 x 3,90 m

~ 126 W

○ | ●

ME ML

NEW



E391 3

~ 0,90 x 3,90 m

~ 84 W

○

ME ML



E405 2

~ 0,75 x 4,10 m

~ 72 W

●

ME ML

NEW



E306 

 ~ 1,05 x 3,10 m

 ~ 96 W



 ME ML

NEW



E307 

 ~ 0,95 x 3,10 m

 ~ 81 W



 ME ML



E502 

 ~ 1,30 x 5,00 m

 ~ 126 W



 ME ML

Wesołych Świąt

E500

2



~ 0,90 x 5,00 m



~ 84 W



ME ML

E500-1

2



~ 0,60 x 3,10 m



~ 51 W



ME ML

Witamy Nowy Rok

E501

3



~ 0,65 x 5,20 m



~ 84 W



ME ML

Szczęśliwego Nowego Roku

E600

3



~ 0,70 x 6,90 m



~ 111 W



ME ML

Kompozycje

Compositions

NEW

3D

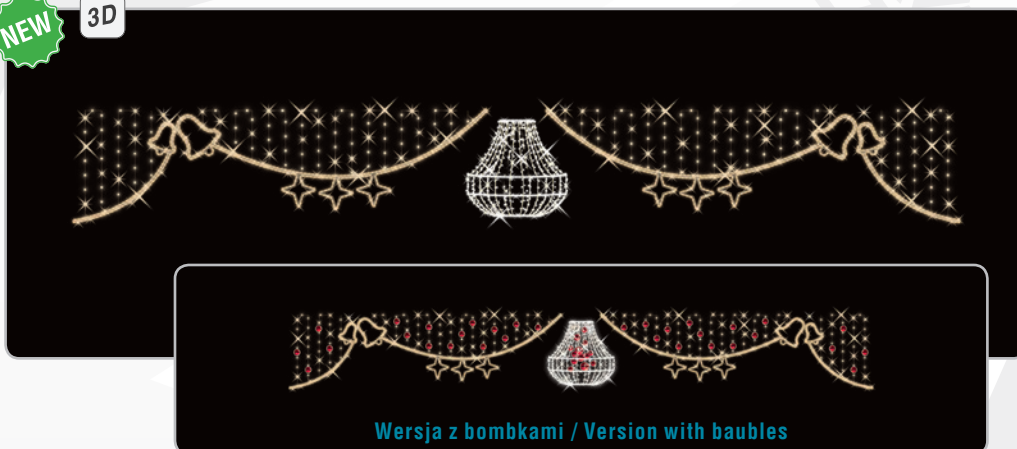

Wersja z bombkami / Version with baubles

P812

5

~ 1,10 x 8,10 m

~ 156 W

○ ● ○ ●

ML

NEW

3D



Wersja z bombkami / Version with baubles

P813

3

~ 1,40 x 7,80 m

~ 197 W

○ ● ○ ●

ML

NEW

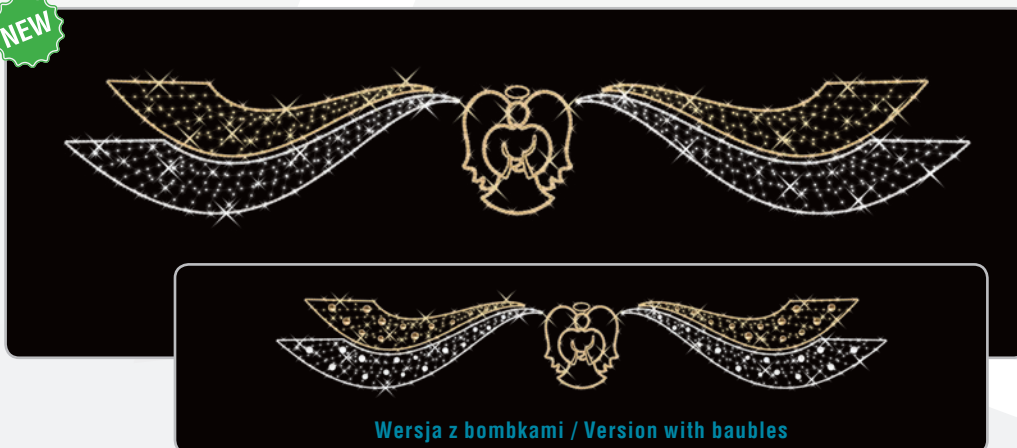

Wersja z bombkami / Version with baubles

P814

3

~ 1,25 x 8,05 m

~ 208 W

○ ● ○ ●

ME ML

3D

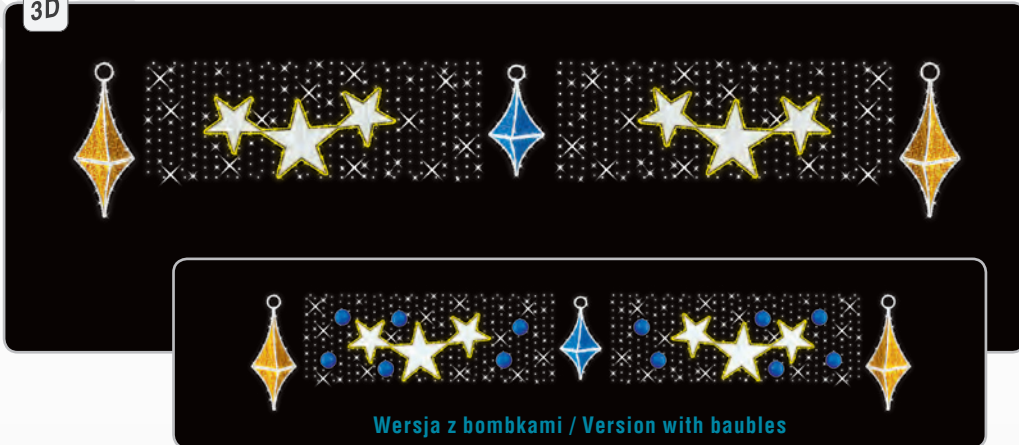

P801

5



~ 1,40 x 7,80 m



~ 172 W



○ ● ○



ML



P802

5



~ 1,40 x 8,00 m



~ 122 W



○ | ○



ME ML

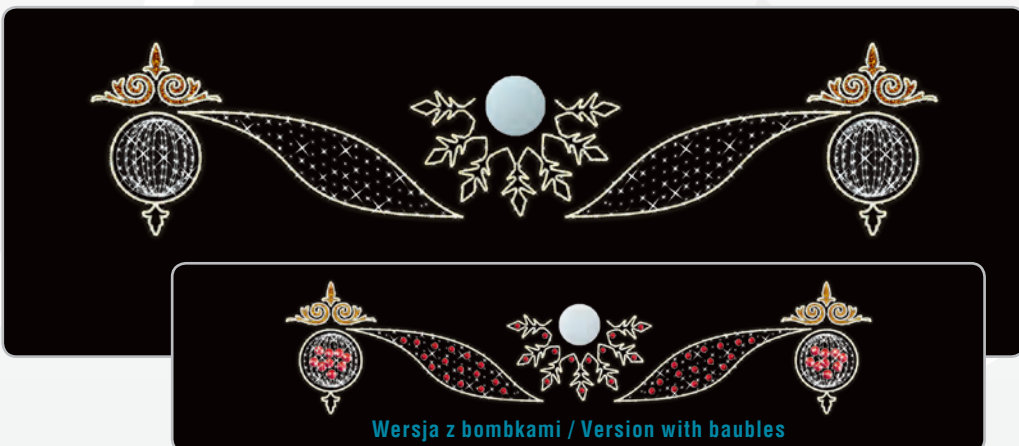

P803

5



~ 1,75 x 7,80 m



~ 200 W



● | ●



ME ML



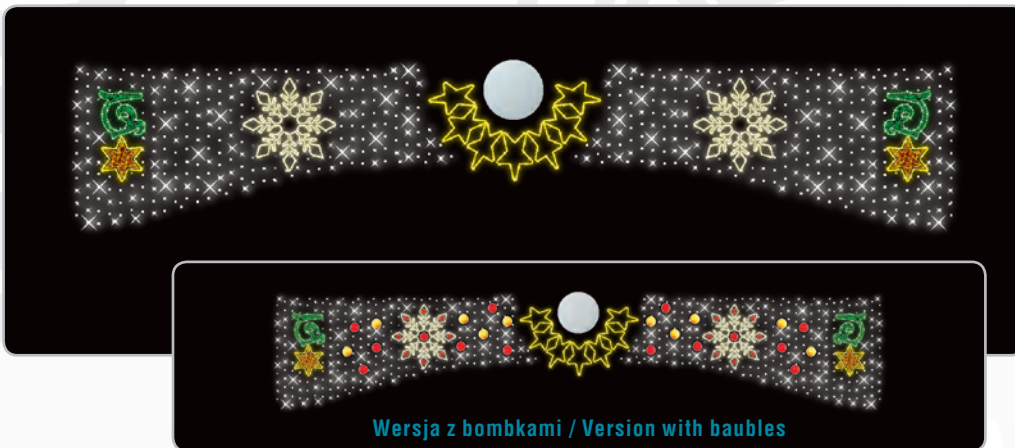

P804 3

~ 1,40 x 8,00 m

~ 190 W

ME ML



P805 5

~ 2,00 x 7,90 m

~ 162 W

ME ML

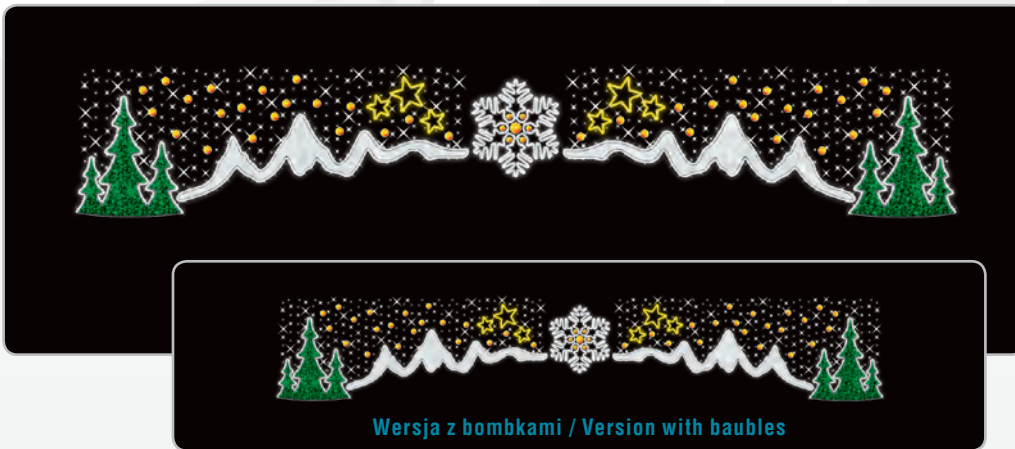

P806 5

~ 1,35 x 8,00 m

~ 202 W

ME ML





P807 8

~ 1,60 x 8,00 m

~ 225 W

ML



Wersja z bombkami / Version with baubles



P808 7

~ 1,80 x 8,00 m

~ 276 W

ML



Wersja z bombkami / Version with baubles

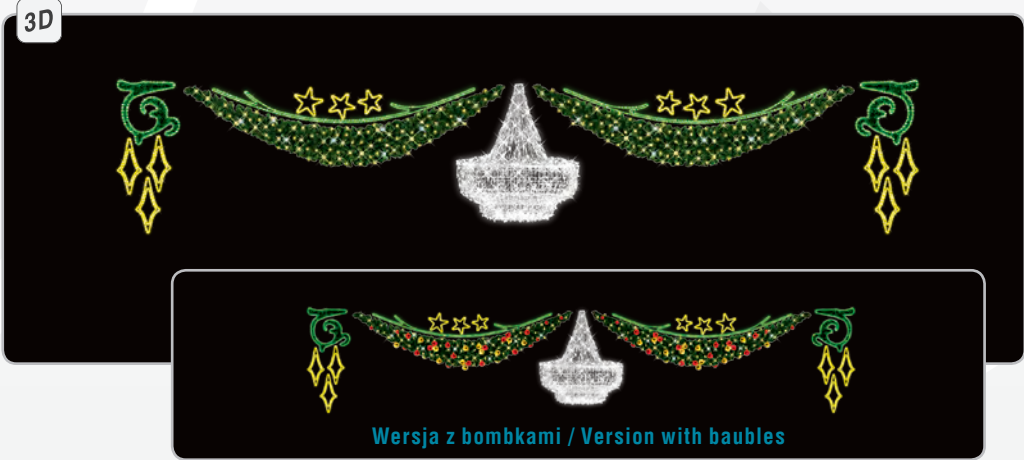

P809 7

~ 1,60 x 8,00 m

~ 238 W

ML



Wersja z bombkami / Version with baubles



3D



Wersja z bombkami / Version with baubles

P810

8

~ 1,60 x 8,00 m

~ 210 W

○ ● ●

ML

3D



Wersja z bombkami / Version with baubles

P811

8

~ 1,70 x 8,00 m

~ 216 W

○ ● ● ●

ML



3D

Przestrzenne

Three-dimensional

NEW

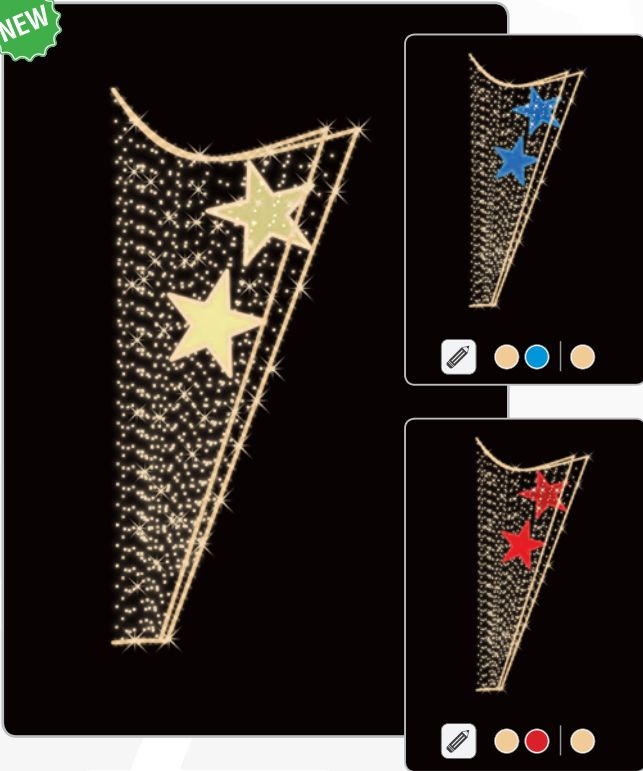

3D110

1



~ 1,75 x 0,80 m



~ 58 W



● ●



MS



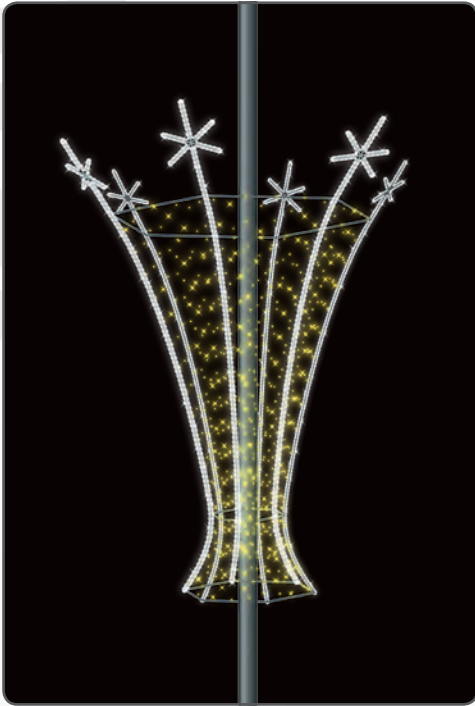

3D301 2

~ 3,00 x 2,10 m

~ 270 W

MS

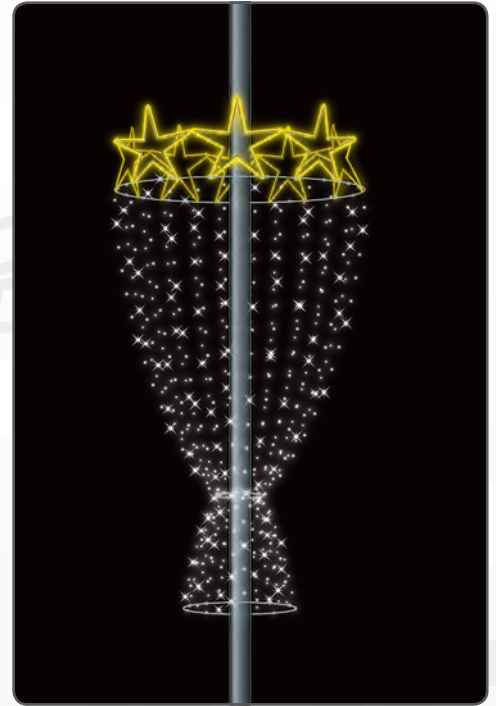

3D302 2

~ 3,25 x 1,60 m

~ 200 W

MS

! PL Składając zamówienie na motyw 3D301/3D302 należy podać średnicę słupa w celu dostosowania mocowania.

EN When putting an order of motif 3D301/3D302, please specify diameter of pole in order to adjust mountings properly.

Choinka przestrzenna

3D christmas tree



3D100 1

~ 1,50 x 0,75 m

~ 33 W

MS

! PL Choinka przestrzenna 3D100 dostępna jest również jako dekoracja wolnostojąca.

EN 3D christmas tree 3D100 is also available as freestanding decoration.

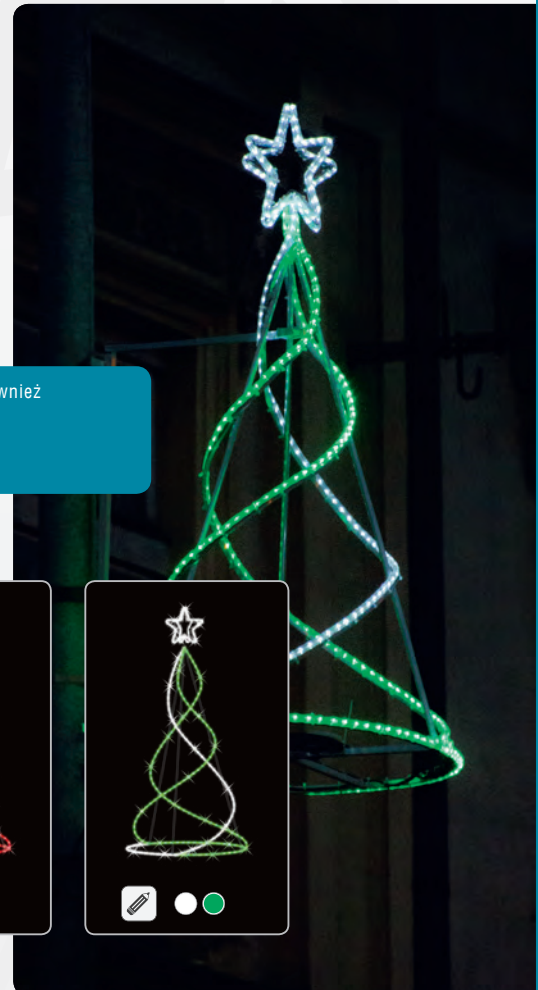

NEW

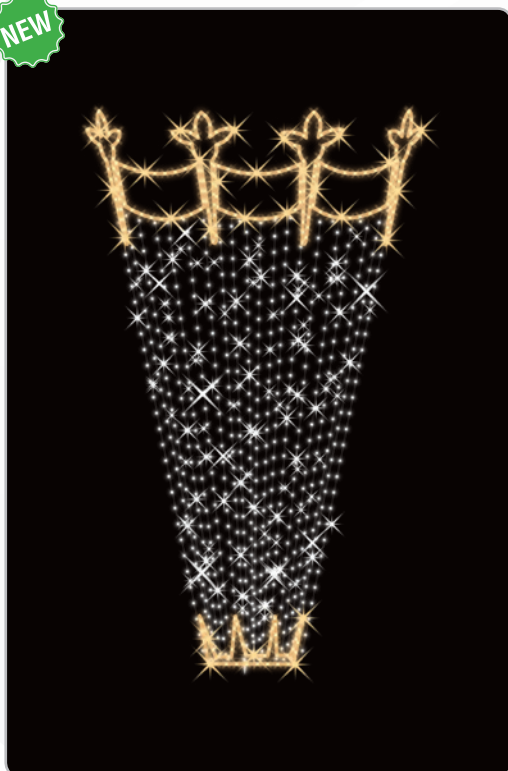

3D200

2



~ 2,00 x 1,20 m



~ 152 W



MS



NEW

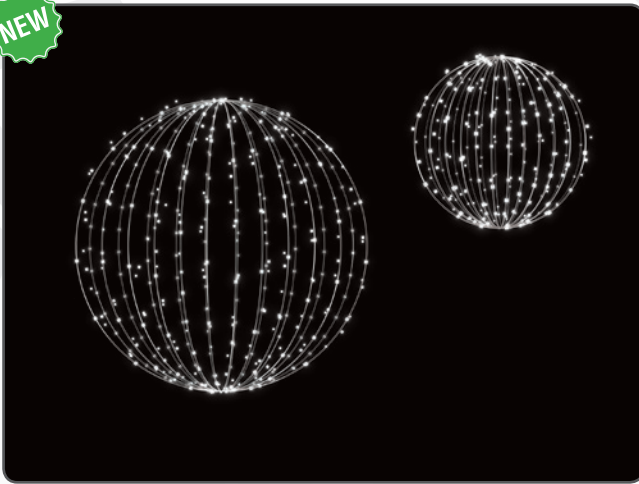

3D002

2

3D002-1

1

∅	~ 1,00 m	~ 0,50 m
⚡	~ 56 W	~ 28 W
✏	○	○
🔧	ML	ML



NEW

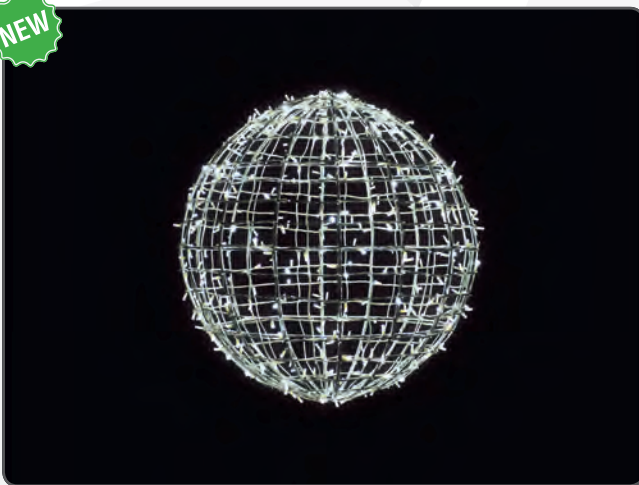

3D004

1

∅	~ 1,10 m
⚡	~ 85 W
✏	○
🔧	ML



PL Motywy 3D002 oraz 3D004 dostępne są również w innych kolorach.

EN Motifs 3D002 and 3D004 are also available in different colours.

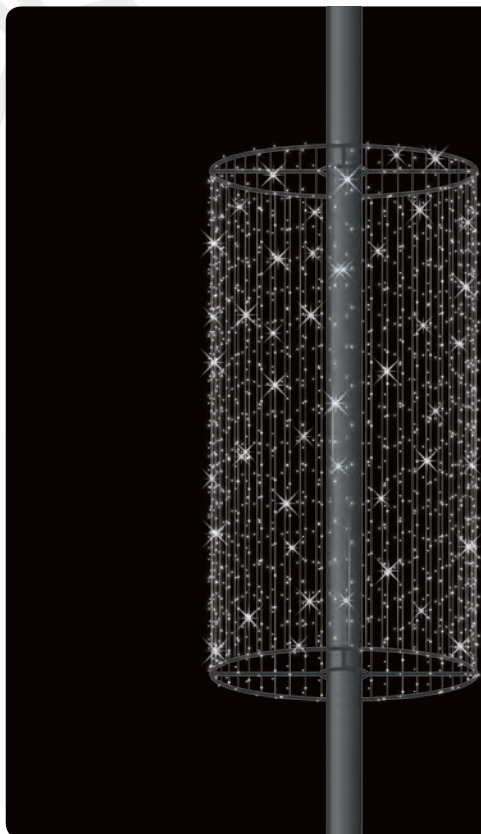

3D300 

 ~ 3,00 x 1,60 m

 ~ 258 W



 MS

Zwieńczenia dekoracji

Finials



3D300-W1 

 ~ 0,15 x 1,60 m

 ~ 36 W





3D300-W2 

 ~ 0,65 x 1,60 m

 ~ 66 W





3D300-W3 

 ~ 0,95 x 1,60 m

 ~ 102 W





PL Składając zamówienie na motyw 3D300 należy podać średnicę słupa w celu dostosowania mocowania.

EN When putting an order of motif 3D300, please specify diameter of pole in order to adjust mountings properly.

3D150

1



~ 1,50 x 0,80 m



~ 129 W



○



MS



Zwieńczenia dekoracji

Finials



3D150-W1

1



~ 0,15 x 0,80 m



~ 18 W



○



3D150-W2

1



~ 0,40 x 0,80 m



~ 30 W



○



3D150-W3

1



~ 0,40 x 0,80 m



~ 51 W



○







Rzeźby *Sculptures*

Kolekcja aniołów, fontann, drzew świetlnych oraz innych dekoracji przestrzennych.
Collection of angels, fountains, light trees and other spatial decorations.

Anioły świetlne

Light angels



PL W grudniu 2005 roku na zamówienie Miasta Krakowa nasza firma rozpoczęła produkcję rzeźb świetlnych. Anioły giganty wykonane w technologii światła LED stały się wyjątkową atrakcją dla mieszkańców, a także odwiedzających to słynne miasto.

Obecnie posiadamy kolekcję aniołów świetlnych różnej wielkości. Kolekcja wyróżnia się bardzo pieczołowicie dopracowanymi sylwetkami, zasługującymi na miano „rzeźb świetlnych”.

Anioły świetlne mogą zawierać światło statyczne lub fleszujące (w co 5 diodzie).

EN In December 2005, on request of the City of Cracow, our company began to produce light sculptures. Giant Angels made in LED light technology has become an unique attraction for residents and visitors of this famous city.

Currently we have a collection of light angels in different sizes. Collection is characterized by very precisely mapped silhouettes.

Light angels can contain static or flashing light (in every 5 diode).



ASH-230-FL



Postumenty

Pedestals

PL Pozwala znacznie lepiej wyeksponować dekorację oraz ochronić ją przed uszkodzeniami. Wysokość postumentu oraz oprawa graficzna za każdym razem dobierana jest wedle uznania Klienta. Powierzchnię można oświetlić oraz wykorzystać jako nośnik reklamy lub życzeń świąteczno-noworocznych.

Więcej informacji na stronie 69.

EN Pedestal allows for better exposure of decorations and protects it against damage. Height of the pedestal and the artwork is always customized. The surface of the pedestal can be illuminated or used as an advertising medium. It is often used for Christmas and New Year's wishes.

More information on page 69.

NEW



AST-150-FL

4

Anioł z trąbką 150 FL
Angel with trumpet 150 FL

-  ~ 1,60 m
-  Rozpiętość skrzydeł / Wingspan: ~ 1,10 m
-  Podstawa / Base: ~ 0,65 m
-  ~ 520
-  ~ 90 W
-  ~ 13 kg
-  

Animacja anioła 360°
Angel animation 360°



<http://dekoracje.campania.pl/qr/ast150>



ASH-230-FL

4

Anioł siedzący grający na harfie 230 FL
Sitting angel playing the harp 230 FL

~ 2,30 m

~ 3560

~ 475 W

~ 40 kg





AFT-350-FL

4

Anioł fruwalący z trąbą 350 FL
Flying angel with trumpet 350 FL

-  ~ 3,70 m
-  Rozpiętość skrzydeł / Wingspan: ~ 2,60 m
-  Podstawa / Base: ~ 1,10 m
-  ~ 2300
-  ~ 310 W
-  ~ 50 kg
-  ● ● ● ●

AFT-220-FL

4

Anioł fruwalący z trąbą 220 FL
Flying angel with trumpet 220 FL

-  ~ 2,20 m
-  Podstawa / Base: ~ 1,00 m
-  ~ 1290
-  ~ 180 W
-  ~ 30 kg
-  ● ● ● ●





AST-250-W

4

Anioł z trąbą 250 W
Angel with trumpet 250 W

↓ ~ 2,50 m

∅ Podstawa / Base: ~ 1,00 m

⊞ ~ 1790

⚡ ~ 250 W

☒ ~ 30 kg

✎ ● ● ●



ASL-230-W

3

Anioł siedzący na ławce 230 W
Angel sitting on a bench 230 W



~ 2,30 m



~ 2440



~ 330 W



~ 30 kg



● ● ● ●





ASS-400-ZAK

6

Anioł ze skrzypcami 400 ZAK
Angel with violin 400 ZAK

↓ ~ 4,00 m

∅ Podstawa / Base: ~ 1,60 m

• ~ 3720

⚡ ~ 370 W

☒ ~ 55 kg

✎ ● ● ●



ASS-350-EX

6

Anioł ekskluzywny ze skrzypcami 350 EX
Exclusive angel with violin 350 EX



~ 3,45 m



~ 3900



~ 380 W



~ 55 kg



● ● ● ●



Fontanny świetlne

Light fountains



PL Fontanny świetlne wykonywane są głównie na indywidualne zamówienia Klientów, dostosowane do krajobrazu, którego częścią się stają. Doskonale nadają się do zastąpienia wyłączanej na czas zimowy fontanny wodnej. Stosowane mogą być dla upiększenia otoczenia i przyciągnięcia uwagi również w ogrodach, parkach, na rynku, w centrum handlowym itp.

Fontanny świetlne oprócz statycznego światła można urozmaicić o:

- ▶ efekt świetlny imitujący płynące stumienia wody
- ▶ możliwość odgrywania melodii i animowanie światła w jej rytm
- ▶ inne efekty na indywidualne zamówienie

EN Light fountains are made mainly on the individual customer orders. They are always adapted to the scenery, which part of they become. It is perfectly suited to replace the water fountain during winter time. They may be used to beautify the surroundings and also to attract attention in gardens, parks, market squares, malls, etc.

Light fountains apart from static light can be enriched by:

- ▶ light effect imitating water stream flow
- ▶ playing melodies and animating the light in her rhythm
- ▶ other effects on an individual order



Zbliżenie na ramiona fontanny
Close-up of fountain's arms construction





Fortepian Chopina, Kraków
Chopin's piano in Cracow



Fontanna przy Teatrze Ziemi Rybnickiej, Rybnik
Fountain beside the Theater, Rybnik



Fontanna na rynku, Nowy Sącz
Fountain, Market square, Nowy Sącz



Fontanna w Bukowinie Tatrzańskiej
Fountain, Bukowina Tatrzańska



Fontanna na rynku, Czechowice-Dziedzice
Fountain, Market square, Czechowice-Dziedzice



Fontanna w Orzeszu
Fountain, Orzesze

NEW



FK-260-WF



Fontanna kielichowa 260 WF
Chalice fountain 260 WF



~ 2,60 m



Kielich / Chalice: ~ 1,55 m
Podstawa / Base: ~ 1,00 m



~ 120 W



Przykładowe szkice fontann

Exemples of fountains' sketches

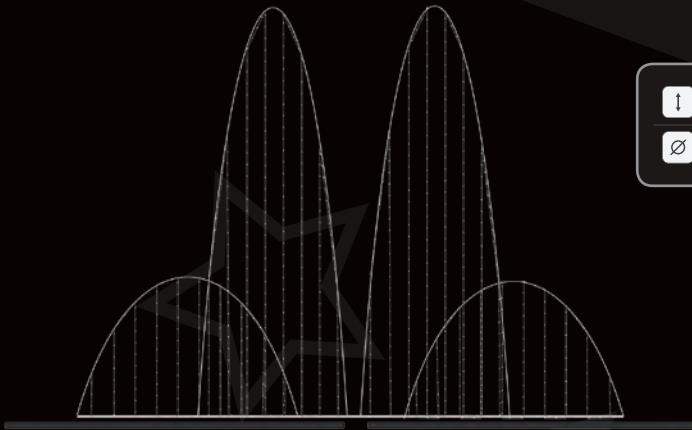

i ~ 3,00 m

∅ ~ 4,00 m

i ~ 3,30 m

∅ ~ 3,00 m

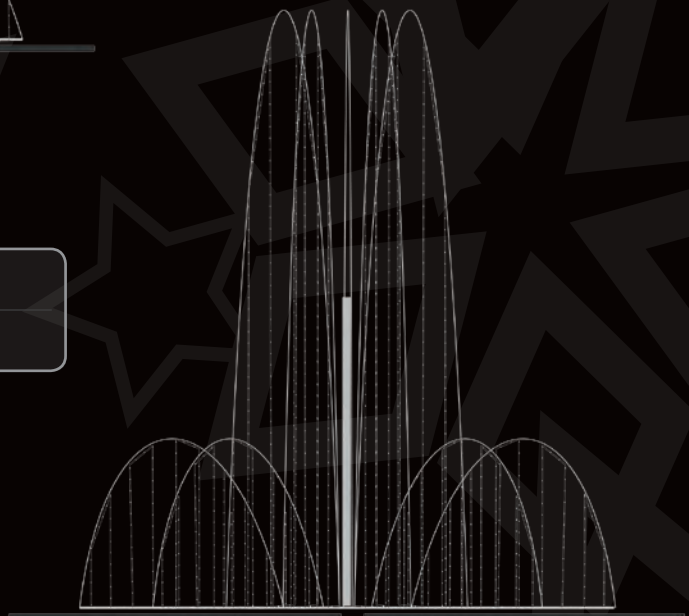

i ~ 1,90 m

∅ ~ 3,40 m



Drzewa świetlne

Light trees



PL Zastanawiałeś się kiedyś, jak można udekorować ładnie ogród, park lub każde inne miejsce, w którym chcemy wprowadzić niezwykły klimat? Doskonale nadają się do tego drzewa świetlne...

Drzewa można użyć jako dekorację zewnętrzną oraz wewnętrzną. Dekorację oferujemy w różnej kolorystyce, a także z możliwością zastosowania sznurów świetlnych FLASH (strona 82).

EN Ever wonder how You can nicely decorate the garden, park or any other place where we want to introduce unusual climate? Light trees are perfectly suited for that...

Trees can be used as external and internal decoration. We offer this decoration in different colours, as well with the possibility of using flash light string (page 82).



DS-320-EX

8

Drzewo świetlne ekskluzywne 320
Exclusive light tree 320

~ 3,20 m

Podstawa / Base: ~ 1,10 m
Korona / Cap: ~ 2,40 m

~ 840

~ 65 W

DS-250

1

Drzewo świetlne 250
Light tree 250

~ 2,50 m

Podstawa / Base: ~ 0,65 m
Korona / Cap: ~ 1,20 m

~ 480

~ 44 W

Postumenty pod rzeźby

Pedestals for sculptures

PL Głównym celem postumentu jest wyeksponowanie dekoracji oraz ochrona przed zniszczeniem. Dodatkową zaletą jest możliwość umieszczenia na niej kolorowej grafiki, takiej jak życzenia czy reklama.

Oferujemy wykonanie postumentu pod daną rzeźbę świetlną wraz z projektem grafiki.

EN The main objective of the pedestal is to expose the decoration and protect it against damage. An additional advantage is the ability to place on it colourful graphics, with wishes or advertisement.

We offer an execution of pedestal under a selected light sculpture also with graphic project.

Podstawowe rodzaje

Basic types

Postument w kształcie sześcianu (ściany kwadratowe)
Pedestal in the shape of a cube (square walls)

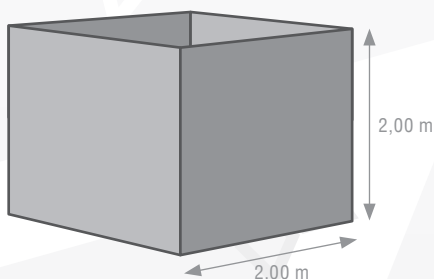

 2,00 x 2,00 x 2,00 m



Postument w kształcie wielościanu (ściany prostokątne)
Pedestal in the shape of a polyhedron (rectangular walls)

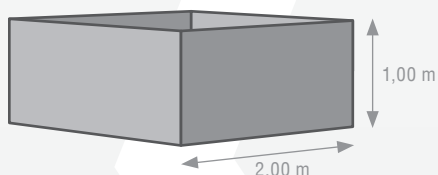

 1,00 x 2,00 x 2,00 m



Postument w kształcie ostrosłupa ściętego (ściany trapezowe)
Pedestal in the shape of a polyhedron truncated pyramid (trapezium walls)

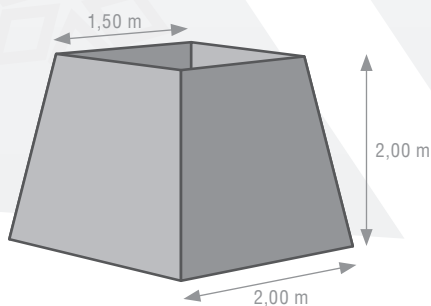

 2,00 x 2,00 x 2,00 m







Materiały dekoracyjne

Decorative materials

*Nadają się doskonale, jako uzupełnienie istniejącej kompozycji, albo indywidualna dekoracja.
They are ideal as a complement to the existing composition or as separate decoration.*



Snowfall™

Snowfall™



PL Wyobraź sobie, że dotykasz czystego, białego śniegu spadającego na chodniki i drzewa... Piękny obraz, który przenosi nas w baśniową atmosferę...

Teraz można odtworzyć ruch spadającego śniegu i cieszyć się jeszcze bardziej ekscytującym widokiem przez cały rok. Wystarczy wykorzystać bardzo jasne diody LED sterowane komputerowo, osłonięte transparentną tubą. Snowfall™ to niewątpliwie hit w branży oświetlenia i dekoracji.

Jesteśmy importerem oryginalnych Snowfall™ pochodzących od bezpośredniego producenta posiadającego licencję patentową.

EN Imagine that You touch the pure white snow falling on the sidewalks and trees... A beautiful picture that takes us in to the fairy-tale atmosphere...

Now you can recreate the movement of the falling snow and enjoy the exciting view throughout the year. Just use a very bright, computer controlled LED diodes, covered with transparent tube. Snowfall™ is undoubtedly a hit in the lighting industry and decoration.

We are an importer of original Snowfall™ comes from direct manufacturer which has a patent license.



Kurтины Snowfall™

Snowfall™ curtains

PL Kurтины zbudowane są z 6 sznurów po 3 tuby na każdym.
EN Curtains are made of 6 strings, each consists of 3 tubes.

	SF135	SF165	SFD165
 Kurтина/Curtain:	1000 x 1450 mm	1000 x 1500 mm	1000 x 1500 mm
 324	324	360	720
 340 g	340 g	630 g	990 g
 1,26 W	1,26 W	1,26 W	1,44 W
 2 kurтины/curtains	1 kurтина/curtain	1 kurтина/curtain	
 1 kurтина/curtain	1 kurтина/curtain	1 kurтина/curtain	

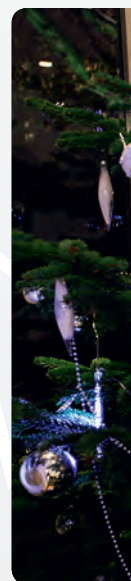
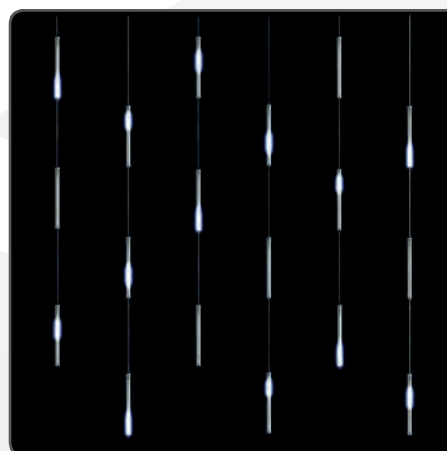

PL Zdjęcia produktów SNOWFALL EUROPE NV z Belgii wykorzystano za zgodą producenta.
EN Photo use of Snowfall EUROPE NV of Belgium product was agreed with the manufacturer.

snowfall™

Sznury Snowfall™

Snowfall™ strings

PL Snowfall™ to sznury świetlnych tub z możliwością łączenia kolejnych sznurów.

EN Snowfall™ are strings of light tubes where one might be joined to another.

∅ 9

SF135

Tuba/Tube:
137 x 9 x 9 mm

18 tuba/tube

7,8 g tuba/tube

0,07 W tuba/tube

10 tub/tubes

5/10 tub/tubes

∅ 12

SF165

Tuba/Tube:
165 x 12 x 12 mm

20 tuba/tube

35 g tuba/tube

0,07 W tuba/tube

20 tub/tubes

5/10/18 tub/tubes

SF350

Tuba/Tube:
350 x 12 x 12 mm

40 tuba/tube

50 g tuba/tube

0,08 W tuba/tube

20 tub/tubes

5/10/18 tub/tubes

SF510

Tuba/Tube:
510 x 12 x 12 mm

60 tuba/tube

65 g tuba/tube

0,08 W tuba/tube

20 tub/tubes

5/10 tub/tubes

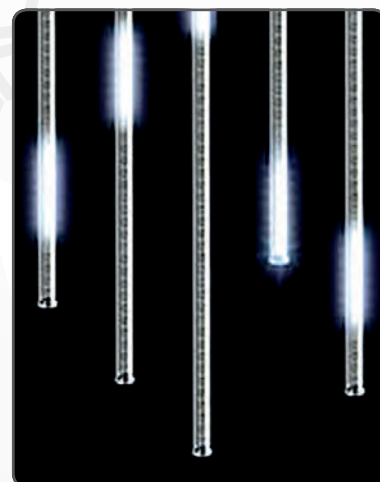

∅ 17

SFD350

Tuba/Tube:
350 x 17 x 17 mm

80 tuba/tube

80 g tuba/tube

0,5 W tuba/tube

20 tub/tubes

5/10 tub/tubes

SFD510

Tuba/Tube:
510 x 17 x 17 mm

120 tuba/tube

105 g tuba/tube

0,28 W tuba/tube

20 tub/tubes

5/10 tub/tubes

∅ 40

SF500

Tuba/Tube:
550 x 40 x 40 mm

60 tuba/tube

375 g tuba/tube

0,52 W tuba/tube

20 tub/tubes

5 tub/tubes

SFD500

Tuba/Tube:
550 x 40 x 40 mm

120 tuba/tube

475 g tuba/tube

0,88 W tuba/tube

20 tub/tubes

5 tub/tubes

SF1000

Tuba/Tube:
1050 x 40 x 40 mm

120 tuba/tube

585 g tuba/tube

0,88 W tuba/tube

20 tub/tubes

5 tub/tubes

SFD1000

Tuba/Tube:
1050 x 40 x 40 mm

240 tuba/tube

735 g tuba/tube

1,36 W tuba/tube

20 tub/tubes

5 tub/tubes



Film pokazowy
Demo film



<http://dekoracje.campania.pl/qr/snowfall>

PL Zdjęcia produktów SNOWFALL EUROPE NV z Belgii wykorzystano za zgodą producenta.

EN Photo use of Snowfall EUROPE NV of Belgium product was agreed with the manufacturer.

snowfall™

Snowball™

PL Śnieżne kule zastępują tradycyjne bombki i zapewniają większą efektywność.

EN Snowballs replace traditional baubles and provide greater effectiveness.



PL Kule występują w różnych wersjach kolorystycznych
EN Balls come in different colours



	SB80 3L	SB80 4L	SB300
	80 mm	80 mm	300 mm
	3 linie/lines: 36 kula/ball	4 linie/lines: 52 kula/ball	6 linii/lines: 234 kula/ball
	65 g kula/ball	85 g kula/ball	1220 g kula/ball
	0,09 W kula/ball	0,10 W kula/ball	0,28 W kula/ball
	3/5 kul/balls	3/5 kul/balls	1 kula/ball

Snowball™ Exaball



PL Przestrzenne kule stworzone z 6 łuków świetlnych wyglądające ciekawie i nowoczesnie. Dodatkowo wewnątrz kuli można umieścić tradycyjne bombki lub inne ciekawe elementy dekoracyjne.

EN Spatial balls made of 6 arcs of light are new way in Christmas decoration that look interesting and modern. Additionally, traditional ornaments or other decorative elements might be put inside of spatial balls.

	EB300	EB480
	300 mm	480 mm
	240 kula/ball	360 kula/ball
	995 g kula/ball	1220 g kula/ball
	0,5 W kula/ball	0,5 W kula/ball
	1 kula/ball	1 kula/ball

Snowball™ Transparent

PL Bezbarwne kule z animowanym motywem wewnętrznym.

EN Transparent balls with an animated inner motive.

	3D	SNOW	STAR
	80 mm	80 mm	80 mm
	38 kula/ball	30 kula/ball	25 kula/ball
	60 g kula/ball	52 g kula/ball	50 g kula/ball
	0,09 W kula/ball	0,14 W kula/ball	0,14 W kula/ball
	3 kule/balls	3 kule/balls	3 kule/balls



3D



SNOW



STAR

PL Zdjęcia produktów SNOWFALL EUROPE NV z Belgii wykorzystano za zgodą producenta.

EN Photo use of Snowfall EUROPE NV of Belgium product was agreed with the manufacturer.

snowfall™

Węże świetlne

Rope light



LED

- Ø ~ 13 mm
- ~ 3 W / 1 m
- 36 / 1 m

Cięcie co 1 lub 2 mb
1 or 2 m cut length

LED

- Ø ~ 13 mm
- ~ 16,4 W / 1 m
- 36 / 1 m

Cięcie co 1 mb
1 m cut length

PL Węże świetlne posiadają całą gamę zastosowań w dekoracjach. Znakomicie nadają się do tworzenia elementów świetlnych, podświetlania konturów budynków, tworzenia napisów oraz nietypowych kształtów świetlnych. Dzięki swoim właściwościom plastycznym można tworzyć najbardziej wyszukane kształty.

Dzięki plastycznym właściwościom węży świetlnych, pozwala na tworzenie bardzo skomplikowanych kształtów. Znajduje on swoje zastosowanie nie tylko w dekoracjach świetlnych, ale również w branży reklamowej (np. świetlne logo, napis).

Akcesoria do węży świetlnych

- ▶ Zestaw zasilający
(przewód zasilający 1,5 m; szpilka zasilająca; uszczelka termokurczliwa; zaślepka; klej),
- ▶ Zestaw naprawczy
(szpilka; koszulka termokurczliwa; klej; paski montażowe),
- ▶ Korytko PCV
(ułatwia równe ułożenie węży),
- ▶ Zaślepka
(do zakończenia węży),
- ▶ Szpilka zasilająca
(do połączenia kabla zasilającego z wężem),
- ▶ Szpilka wąż-wąż
(do łączenia odcinków węży),
- ▶ Kabel zasilający 1,5 m; 2,5 m; 3,5 m;

EN Rope light have a wide range of lighting applications in the decorations. They are ideally suited for creating the light elements, highlighting the contours of buildings, creating titles and unusual shapes of light. Due to its plastic properties, it can be use to create the most sophisticated shapes.

Rope light with its malleable qualities allows to create complex shapes. It is used not only for light decoration but also in advertising industry (eg. light logo, sign).

Rope light accessories

- ▶ Power Kit
(power cord 1.5 m; power pin; heat shrink splice; end cap; glue),
- ▶ Repair Kit
(power pin; heat shrink splice; glue; mounting belts),
- ▶ PVC channel,
(facilitates equal position of rope light),
- ▶ End cap
(at the end of rope light),
- ▶ Power pin
(to connect the power cord with rope light),
- ▶ Rope-to-rope pin
(to connect the sections of rope light),
- ▶ Power cable 1,5 m; 2,5 m; 3,5 m;



PL Oferujemy również inne rodzaje węży świetlnych (m.in. animowane) na indywidualne zapytanie.

EN We also offer other types of rope light (e.g. animated) on individual inquiry.

Girlanda żarówkowa

Garland bulbs



PL Girlandy żarówkowe tworzą niezwykle dekoracje świetlne, widoczne z dużej odległości. Nadają się znakomicie do dekorowania dużych choinek, mogą być także wykorzystane do podświetlenia fasad, portali i elewacji.

Odległości między oprawkami (żarówkami) dostosowywane są indywidualnie do potrzeb Klienta.

EN Bulb garlands create an unique light decorations, visible from a distance. They are ideal to decorate the large trees, may be also used to illuminate facades, portals and elevations.

Distance between bulbs may be customized to meet individual customer's needs.



Żarówki

Bulbs



LED

Żarówki kolorowe LED

LED coloured bulbs

PL Żarówki zawierają diody zamkniętych w hermetycznej oprawce z tworzywa sztucznego, co zapewnia szczelność przed kontaktem z wodą i zwiększoną odporność na uszkodzenia mechaniczne.

EN Bulbs contain diodes sealed in a hermetic plastic cover that ensures water resistance and improved resistance to mechanical damage.



∅ ~ 45 mm

⚡ ~ 1 W



Mocowanie / Bulb base:
E27, B22



Żarówki kolorowe tradycyjne

Traditional coloured bulbs

PL Żarówki kolorowe ze szklanymi oprawkami w kolorze świecenia, stosowane m.in. w girlandach żarówkowych na zewnątrz i do wewnątrz.

EN Coloured bulbs with coloured glass cover used among others for the indoor and outdoor garlands.



∅ ~ 45 mm

⚡ ~ 10-25 W



Mocowanie / Bulb base:
E27, B22



Żarówki stroboskopowe

Strobe bulbs

PL Oświetlenie stroboskopowe emituje światło błyskowe nadające ciekawy efekt w dekoracjach wszelkiego rodzaju. Znajduje zastosowania m.in. w dekoracjach słupowych i elewacyjnych, girlandach żarówkowych.

EN Strobe light emits a flashing light that gives an interesting effect. It is used for house fronts and street lamps decorations, also in bulb garlands.



∅ ~ 50 mm

⚡ ~ 5 W



Mocowanie / Bulb base:
E27



Żarówki LED zmieniające kolor

LED colour changing bulbs

PL Żarówki zmieniające kolory w równym odstępie czasu.

EN Colour changing bulbs in equal intervals of time.

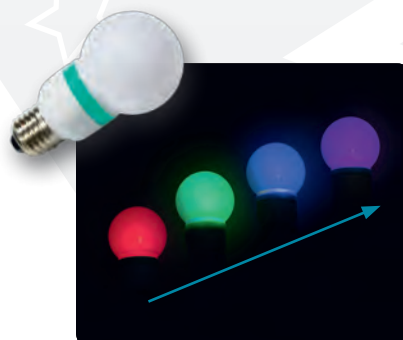

∅ ~ 60 mm

⚡ ~ 1 W



Mocowanie / Bulb base:
E27

Sople świetlne

Light icicle



PL Sople świetlne to niezwykle widowiskowa dekoracja. Mogą być wykorzystane do podkreślania elewacji, daszków itp. Dodatkowo pozwalają wprowadzić zimowy klimat także wewnątrz budynku. Sople nadają dekorowanym obiektom tradycyjny świąteczno-zimowy charakter.

EN Light icicle is a very spectacular decoration. It is used to decorate house fronts, roofs etc. Additionally it lets you create the winter climate inside the building. Light icicle gives traditional Christmas-winter spirit to the decorated places.



PL Oferujemy również inne rodzaje sopli świetlnych na indywidualne zapytanie.

EN We also offer other types of light icicle on individual inquiry.



Sople świetlne FLASH

Light icicle FLASH



LSP-180-FL

LED-RPLR-180(60°3)-4,5x0,8M

	~ 4,50 m
	~ 0,80 m
	3 (3 x 1,50 m)
	180
	~ 34 W
	3 kpl./set
	Flash: <input type="checkbox"/>

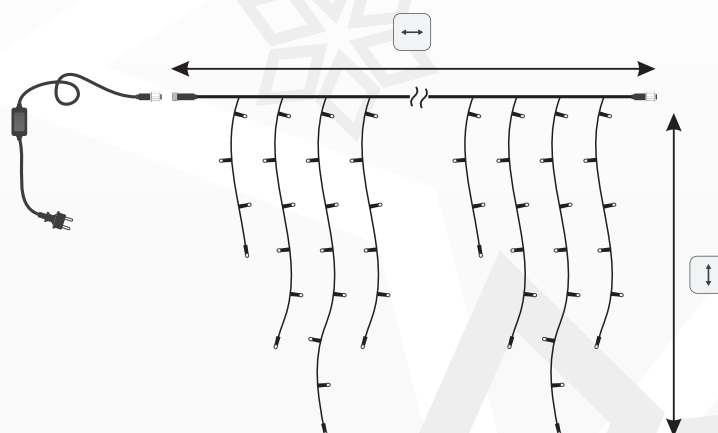

Co 6 dioda mrugająca.
Every 6th diode flashing.



LSP-190

LED-R-[C]-190

	~ 5,00 m
	~ 0,70 m
	5 (5 x 1,00 m)
	190
	~ 25 W
	15 kpl./sets
	<input type="checkbox"/>



LSP-180/W

LED-RPLR-180(60x3)-4,5x0,8M

	~ 4,50 m
	~ 0,80 m
	3 (3 x 1,50 m)
	180
	~ 12 W
	6 kpl./sets
	<input type="checkbox"/>



LSP-180/G

LED-RPLR-180(60x3)-4,5x0,8M

	~ 4,50 m
	~ 0,80 m
	3 (3 x 1,50 m)
	180
	~ 12 W
	6 kpl./sets
	<input type="checkbox"/>



LSP-300

LED-RPLR-300(75x4)-4,0x1,5M

	~ 4,00 m
	~ 1,50 m
	4 (4 x 1,00 m)
	300
	~ 30 W
	4 kpl./sets
	<input type="checkbox"/>



LSP-60

LED-RPLR-60(30x2)-4,0x0,5M

	~ 3,00 m
	~ 0,50 m
	2 (2 x 1,50 m)
	60
	~ 8 W
	50 kpl./sets
	<input type="checkbox"/>



SP-190-70

RPLR-190-0,7

	~ 5,00 m
	~ 0,70 m
	5 (5 x 1,00 m)
	190
	~ 138 W
	4 kpl./sets
	<input type="checkbox"/>



SP-190-120

RPLR-190-1,2

	~ 5,00 m
	~ 1,20 m
	5 (5 x 1,00 m)
	190
	~ 138 W
	4 kpl./sets
	<input type="checkbox"/>



SP-304

RPLR-304(38x8)-4x0,9M

	~ 4,00 m
	~ 0,90 m
	8 (8 x 0,50 m)
	304
	~ 138 W
	3 kpl./sets
	<input type="checkbox"/>



SP-304-A

RPLR-304(38x8)-4x0,9M-A

	~ 4,00 m
	~ 0,90 m
	8 (8 x 0,50 m)
	304
	~ 138 W
	3 kpl./sets
	<input type="checkbox"/>



WSP-152

RPLR-152(38x4)-4x0,9M

	~ 4,00 m
	~ 0,90 m
	4 (4 x 1,00 m)
	152
	~ 69 W
	8 kpl./sets
	<input type="checkbox"/>



PL Oferujemy również inne rodzaje sopli świetlnych na indywidualne zapytanie.

EN We also offer other types of light icicles on individual inquiry.

Kurtyny świetlne

Light curtains



PL Kurtyny świetlne są jedną z najpopularniejszych dekoracji. Sprawdzają się nie tylko jako osobna dekoracja, ale również jako uzupełnienie kompozycji złożonej z innych elementów. Kurtyny świetlne to doskonała dekoracja drzew i choinek, elewacji, balkonów i wielu innych obiektów.

EN Light curtains are one of the most popular decoration. They are used as a separate decoration as well as a complement of existing composition. Light curtains are ideal for decorating trees, facades, balconies and many other objects.

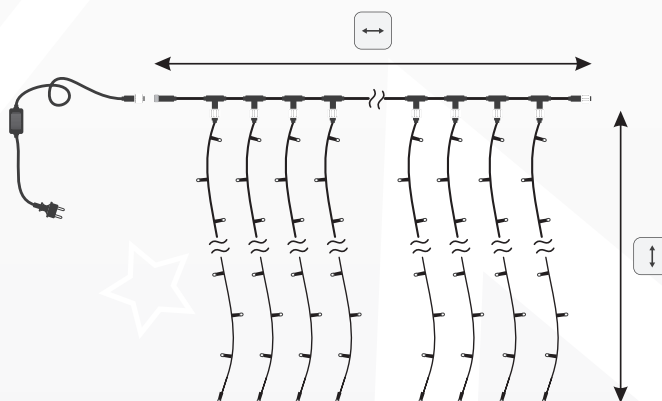

LED



LKR-2515



LKR-2530



LKR-2550



LEDR-[C]-1,5

LEDR-[C]-3

LEDR-[C]-5



~ 1,50 m

~ 3,00 m

~ 5,00 m



~ 2,50 m

~ 2,50 m

~ 2,50 m



25

25

25



475

925

1025



~ 66 W

~ 129 W

~ 169 W



8 kpl./sets

4 kpl./sets

3 kpl./sets



○ ● ● ● ●

○ ● ● ● ●

○ ● ● ● ●



PL Powyższe kurtyny dostępne również z mrugającymi białymi diodami.
EN Above light curtains are also available with flashing white diodes.

LED



LKR-2530/W



LKR-2630



LKR-2550/W



LKR-2660



LEDR-[C]-1,5/W

LED-PLRS-3725-2,6x3M

LEDR-[C]-3/W

LED-PLRS-3725-2,6x6M



~ 3,00 m

~ 3,00 m

~ 5,00 m

~ 6,00 m



~ 2,50 m

~ 2,60 m

~ 2,50 m

~ 2,60 m



25

25

25

25



925

925

1025

1425



~ 129 W

~ 123 W

~ 169 W

~ 185 W



4 kpl./sets

4 kpl./sets

3 kpl./sets

2 kpl./sets



○

○ ●

○

○

PL Oferujemy również inne rodzaje kurtyn świetlnych na indywidualne zapytanie.

EN We also offer other types of light curtains on individual inquiry.



PL Kurtyny świetlne z co 5-6 diodą mrugającą.

EN Light curtains with every 5th-6th diode flashing.

NEW

Kurtyny ekonomiczne Economical curtains

LED



ELKR-15



ELKR-30



ELKR-60



ELKR-90



ELKR-30-FL



ELKR-60-FL



EKO-PLRS-1516-2x1,5M

EKO-PLRS-4815-2x3M

EKO-PLRS-4815-2x6M

EKO-PLRS-7215-2x9M

EKO-PLRS-3018-2x3M-F

EKO-PLRS-6018-2x6M-F



~ 1,50 m

~ 3,00 m

~ 6,00 m

~ 9,00 m

~ 3,00 m

~ 6,00 m



~ 2,00 m

~ 2,00 m

~ 2,00 m

~ 2,00 m

~ 2,00 m

~ 2,00 m



16

16

15

15

18

18



240

384

720

1080

540

1080



~ 29 W

~ 46 W

~ 86 W

~ 129 W

~ 64 W

~ 129 W



11 kpl./sets

11 kpl./sets

6 kpl./sets

5 kpl./sets

10 kpl./sets

5 kpl./sets



Flash:

Flash:

LED



LKR-2530-FL/W



LKR-2550-FL/W



LKR-2630-FL



LKR-2660-FL



LEDR-[C]-1,5-FLASH/W

LEDR-[C]-3-FLASH/W

LED-PLRS-3625-2,6x3M-F

LED-PLRS-6025-2,6x6M-F



~ 3,00 m

~ 5,00 m

~ 3,00 m

~ 6,00 m



~ 2,50 m

~ 2,50 m

~ 2,60 m

~ 2,60 m



25

25

25

25



925

1025

900

1500



~ 129 W

~ 169 W

~ 64 W

~ 129 W



4 kpl./sets

3 kpl./sets

3 kpl./sets

3 kpl./sets



Flash:

Flash:

Flash:

Flash:

LED



KR-2715



KR-2730



KR-2630



KR-2750



KR-2790



PLR-1925

PLR-3725

PLRS-3725-2,6x3M

PLR-5725

PLR-9025



~ 1,50 m

~ 3,00 m

~ 3,00 m

~ 5,00 m

~ 9,00 m



~ 2,70 m

~ 2,70 m

~ 2,60 m

~ 2,70 m

~ 2,60 m



25

25

25

25

25



475

925

925

1425

2250



~ 266 W

~ 555 W

~ 420 W

~ 648 W

~ 850 W



3 kpl./sets

2 kpl./sets

2 kpl./sets

1 kpl./set

1 kpl./set



LED



KR-2615



KR-2650



PLR-1925

PLR-3725



~ 1,50 m

~ 3,00 m



~ 2,70 m

~ 2,70 m



25

25



475

925



~ 266 W

~ 555 W



3 kpl./sets

2 kpl./sets



PL Oferujemy również inne rodzaje kurtyn świetlnych na indywidualne zapytanie.

EN We also offer other types of light curtains on individual inquiry.

Sznury świetlne

Light strings



PL Sznury świetlne, zwane również warkoczami lub łańcuchami świetlnymi, nadają się do dekoracji drzew, krzewów, choinek, witryn itp. Bogata kolorystyka pozwala na dobór dekoracji według indywidualnych potrzeb. Istnieje możliwość łączenia ze sobą kilku kompletów w jeden dłuższy ciąg.

EN Light strings are suitable for decorating trees, shrubs, christmas trees, shop windows etc. Wide range of colours allows the selection of decorations according to individual needs. There is a possibility of joining several sets into one long string composition.

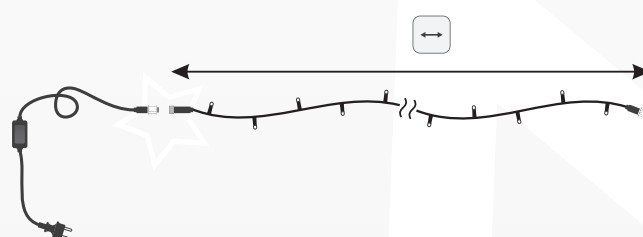

NEW

Sznur świetlny z kryształkami

Light string with crystals



WLSZ-60-KR

LED-PL-60-6M

←→	~ 6,00 m
⋮	1 (1 x 6 m)
⋯	60
⚡	~ 5 W
max	8 kpl./sets
✎	●



LSZ-100

LED-PLR-100-10M

←→	~ 10,00 m
⋮	1 (1 x 10 m)
⋯	100
⚡	~ 12 W
max	10 kpl./sets
✎	● ● ●



LSZ-100-2

LED-PLR-100(50x2)-10M

←→	~ 10,00 m
⋮	2 (2 x 5 m)
⋯	100
⚡	~ 12 W
max	10 kpl./sets
✎	● ● ● ● ●



LSZ-100-FL

LED-PLR-100(50x2)-10M

←→	~ 10,00 m
⋮	2 (2 x 5 m)
⋯	100
⚡	~ 12 W
max	10 kpl./sets
✎	● ● ● Flash: ○



LSZ-120-FL

LED-PLR-120(50x2)-10M

←→	~ 12,00 m
⋮	3 (3 x 4 m)
⋯	120
⚡	~ 13 W
max	10 kpl./sets
✎	● ● Flash: ○

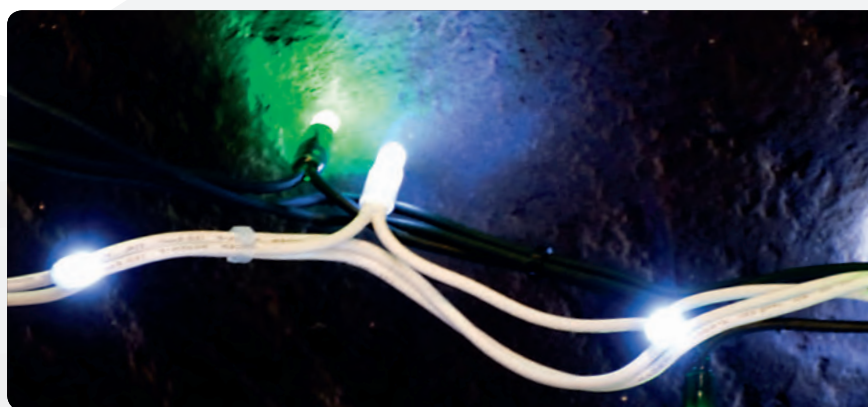

PL Oferujemy również inne rodzaje sznurów świetlnych na indywidualne zapytanie.

EN We also offer other types of light strings on individual inquiry.

LED	LED	LED	LED	LED	LED
LSZ-80-2 LED-PLR-80(40x2)-12M	LSZ-80 LED-PLR-80-12M	LSZ-160 LEDR-(C)-160	LSZ-120 LED-PLR-120(60x2)-20M	LSZ-250 LEDR-(C)-250	
~ 12,00 m	~ 12,00 m	~ 20,00 m	~ 20,00 m	~ 25,00 m	
2 (2 x 6 m)	1 (1 x 12 m)	4 (4 x 5 m)	2 (2 x 10 m)	5 (5 x 5 m)	
80	80	160	120	250	
~ 12 W	~ 12 W	~ 23 W	~ 14 W	~ 35 W	
10 kpl./sets	10 kpl./sets	8 kpl./sets	10 kpl./sets	5 kpl./sets	

LED	LED	LED	LED	LED
LSZ-100-FLM LED-PLR-100(50x2)-10M	LSZ-100-FLM LED-PLR-100(50x2)-10M	LSZ-80-FLM LED-PLR-80(40x2)-10M	LSZ-80-FLM LED-PLR-80-12M	
~ 10,00 m	~ 10,00 m	~ 12,00 m	~ 12,00 m	
2 (2 x 5 m)	2 (2 x 5 m)	2 (2 x 6 m)	2 (2 x 6 m)	
100	100	80	80	
~ 12 W	~ 12 W	~ 12 W	~ 12 W	
10 kpl./sets	10 kpl./sets	10 kpl./sets	10 kpl./sets	

LED	LED	LED
WLSZ-80 LED-PL-80-12M	WLSZ-80-2 LED-PL-80(40x2)-12M	WLSZ-80-2 LED-PL-100(50x2)-10M
~ 12,00 m	~ 12,00 m	~ 10,00 m
1 (1 x 12 m)	2 (2 x 6 m)	2 (2 x 5 m)
80	80	100
~ 12 W	~ 12 W	~ 12 W
10 kpl./sets	10 kpl./sets	10 kpl./sets

LED	LED
WLSZ-100-FL LED-PL-100(50x2)-10M	
~ 10,00 m	
2 (2 x 5 m)	
100	
~ 12 W	
10 kpl./sets	

LED	LED	LED
SZ-120 STD-PL-120(40x3)-12	SZ-150 PLR-15	SZ-250 PLR-25
~ 12,00 m	~ 15,00 m	~ 25,00 m
3 (3 x 4 m)	3 (3 x 5 m)	5 (5 x 5 m)
120	150	250
~ 69 W	~ 75 W	~ 130 W
3 kpl./sets	3 kpl./sets	3 kpl./sets

PL Sznury świetlne z co 5-6 diodą mrugającą.

EN Light strings with every 5th-6th diode flashing.

PL Oferujemy również inne rodzaje sznurów świetlnych na indywidualne zapytanie.

EN We also offer other types of light strings on individual inquiry.

Choinki

Christmas trees

PL Prezentujemy ofertę choinek. Do oświetlenia choinek i drzew proponujemy sznury świetlne i girlandy żarówkowe. Posiadamy również bogatą ofertę dekoracji dziennych.

EN We present an offer of Christmas trees. Bulb garlands and light strings might be used to decorate trees and Christmas trees. We also have wide range of day decorations.

Milenijna / Milenium



↑	∅	🌳
150 cm	100 cm	410
180 cm	120 cm	734
210 cm	140 cm	1142
240 cm	160 cm	1622

Exclusive



↑	∅	🌳
120 cm	90 cm	404
130 cm	92 cm	500
150 cm	126 cm	536
180 cm	145 cm	891
210 cm	155 cm	1346
240 cm	165 cm	1636

Slim-Line



↑	∅	🌳
150 cm	84 cm	425
180 cm	102 cm	725
210 cm	120 cm	945
240 cm	140 cm	1345

PL Oferujemy również inne rodzaje i wymiary choinek.

EN We also offer other types and sizes of Christmas trees.

Carmen



↑	∅	🌲
150 cm	102 cm	442
180 cm	126 cm	778
210 cm	130 cm	1128
240 cm	150 cm	2088

Lena



↑	∅	🌲
120 cm	75 cm	138
150 cm	90 cm	222
180 cm	100 cm	318
210 cm	115 cm	474
240 cm	125 cm	594

Naturalna / Natural



↑	∅	🌲
150 cm	120 cm	954
180 cm	135 cm	1434
210 cm	140 cm	2154
240 cm	160 cm	2682

Perfekt / Perfect



↑	∅	🌲
150 cm	120 cm	506
180 cm	135 cm	711
210 cm	155 cm	1156
240 cm	165 cm	1466

Silhouetta



↑	∅	🌲
150 cm	57 cm	242
180 cm	70 cm	372
210 cm	80 cm	542
240 cm	90 cm	722
300 cm	118 cm	1182
400 cm	186 cm	4044

Piramida / Pyramid



↑	∅	🌲
150 cm	55 cm	3342
180 cm	65 cm	4040
210 cm	75 cm	5036
240 cm	85 cm	6530

PL Oferujemy również inne rodzaje i wymiary choinek.

EN We also offer other types and sizes of Christmas trees.

Verona



↑	∅	🌲
180 cm	102 cm	831
210 cm	118 cm	1227
240 cm	129 cm	1556
270 cm	138 cm	1664

Świerk alpejski Alpine Spruce



↑	∅	🌲
120 cm	59 cm	435
150 cm	61 cm	565
180 cm	82 cm	751
210 cm	107 cm	1134

Standard



↑	∅	🌲
150 cm	110 cm	305
180 cm	120 cm	417
210 cm	140 cm	749
240 cm	150 cm	989

Stożek / Cone Tree



↑	∅	🌲
150 cm	45 cm	610
180 cm	50 cm	726
210 cm	55 cm	874
240 cm	60 cm	1018

Gloria



↑	∅	🌲
160 cm	70 cm	343
180 cm	78 cm	514
210 cm	85 cm	883
240 cm	90 cm	1180

Oliwia / Olivia



↑	∅	🌲
150 cm	90 cm	222
180 cm	100 cm	318
220 cm	115 cm	474
240 cm	125 cm	594

PL Oferujemy również inne rodzaje i wymiary choinek.

EN We also offer other types and sizes of Christmas trees.

Cindy



↑	∅	🌲
180 cm	110 cm	154
220 cm	135 cm	200
240 cm	145 cm	326

Diana



↑	∅	🌲
180 cm	110 cm	154
220 cm	135 cm	200
240 cm	145 cm	326

Królewska / Royal



↑	∅	🌲
150 cm	80 cm	236
180 cm	100 cm	386
210 cm	120 cm	618
240 cm	130 cm	746

Premium



↑	∅	🌲
180 cm	120 cm	906
210 cm	125 cm	1166
240 cm	135 cm	1494

Tundra



↑	∅	🌲
180 cm	118 cm	578
210 cm	128 cm	872
240 cm	139 cm	1120

Tajga / Taiga



↑	∅	🌲
180 cm	138 cm	502
210 cm	145 cm	664
240 cm	150 cm	868

PL Oferujemy również inne rodzaje i wymiary choinek.

EN We also offer other types and sizes of Christmas trees.

Gigant Standard



↑	∅	☀
370 cm	160 cm	1000
440 cm	190 cm	1540
510 cm	220 cm	2260
580 cm	245 cm	3124
↓	↓	↓
2400 cm	948 cm	89416

Gigant Exclusive



↑	∅	☀
460 cm	230 cm	5624
530 cm	260 cm	8216
600 cm	290 cm	12104
670 cm	320 cm	17288
↓	↓	↓
1510 cm	750 cm	179720

Vario Nature



↑	∅	☀
460 cm	230 cm	5624
530 cm	260 cm	8216
600 cm	290 cm	12104
670 cm	320 cm	17288
↓	↓	↓
1510 cm	750 cm	179720



PL Oferujemy również inne rodzaje i wymiary choinek.

EN We also offer other types and sizes of Christmas trees.

Girlandy

Garlands

Girlanda Rogal McLine / Twirl McLine Garland



Standard

↔	∅	☰
200 cm	14-30 cm	310
270 cm	14-45 cm	625
500 cm	14-65 cm	1350
600 cm	14-65 cm	1590

DeLuxe

↔	∅	☰
80 cm	14-30 cm	200
120 cm	14-30 cm	245
180 cm	14-35 cm	290
270 cm	14-35 cm	340
400 cm	14-50 cm	790
500 cm	14-60 cm	1022

Girlanda Fason McLine / Fashion McLine Garland



↔	∅	☰
2x35/200 cm	14-30 cm	390
2x40/270 cm	14-45 cm	800
2x70/400 cm	14-65 cm	1000
2x70/500 cm	14-65 cm	1230



Girlanda Świerkowa / Spruce Garland

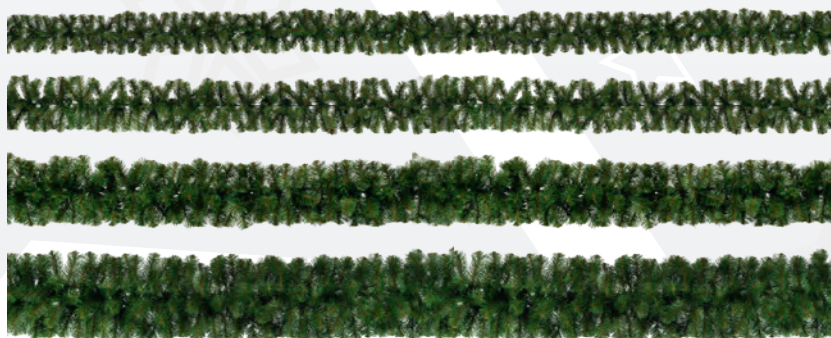

↔	∅	☰
270 cm	20 cm	210
270 cm	25 cm	210
270 cm	30 cm	210
270 cm	40 cm	210

PL Oferujemy również inne rodzaje i wymiary girland.

EN We also offer other types and sizes of garlands.

Girlanda Apollo / Apollo Garland



Standard

↔	∅	🌿
270 cm	17 cm	320
270 cm	25 cm	320
270 cm	30 cm	320
540 cm	17 cm	640
540 cm	25 cm	640
540 cm	30 cm	640

DeLuxe

↔	∅	🌿
270 cm	17 cm	378
270 cm	25 cm	448
270 cm	30 cm	540
540 cm	17 cm	756
540 cm	25 cm	896
540 cm	30 cm	1080

Girlanda Królewska / Royal Garland



↔	∅	🌿
100 cm	15 cm	204
100 cm	20 cm	240
100 cm	25 cm	288
100 cm	30 cm	320
100 cm	40 cm	384
100 cm	50 cm	410
100 cm	60 cm	432

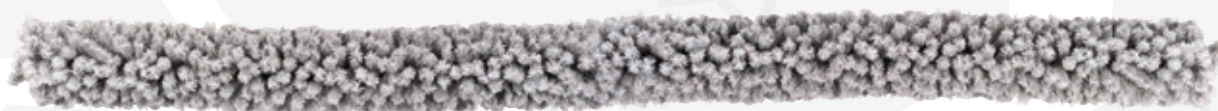

Girlanda Królewska McLine / Royal McLine Garland

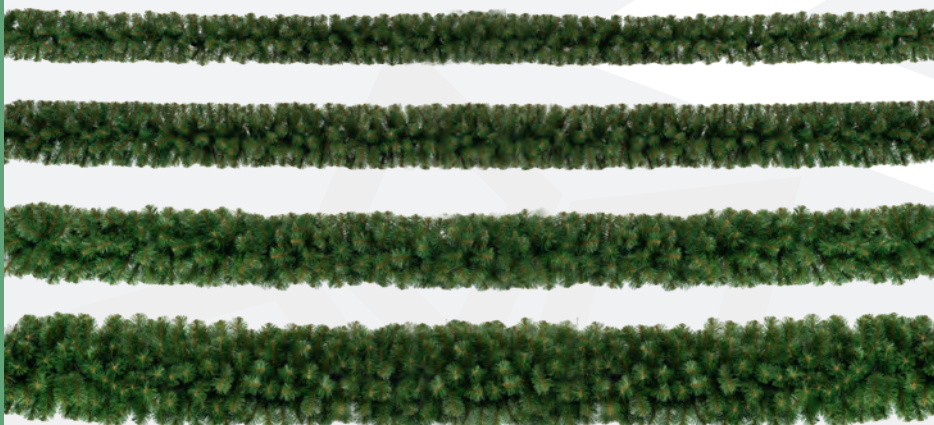

↔	∅	🌿
100 cm	20 cm	145
100 cm	25 cm	145
100 cm	30 cm	145
100 cm	35 cm	145
100 cm	40 cm	210
100 cm	50 cm	210

PL Oferujemy również inne rodzaje i wymiary girland.

EN We also offer other types and sizes of garlands.

Wianki

Wreaths

Królewski / Royal



120/60 cm	220/120 cm
120/40 cm	250/150 cm
200/100 cm	300/200 cm
200/120 cm	

Czesany / Combed



30/15 cm	80/40 cm	150/70 cm
40/20 cm	100/50 cm	180/100 cm
50/25 cm	120/40 cm	
60/30 cm	120/60 cm	

Gwiazda / Star



90 cm	140 cm
100 cm	150 cm
120 cm	185 cm
130 cm	200 cm

 zewnętrzna/wewnętrzna (outer/inner)

Kule

Spruce balls

PL Kule wypełniane są kolorową matą dekoracyjną lub igliwem. Proponujemy również udekorowanie ich światłem i innymi elementami dekoracyjnymi.

EN Spruce balls are filled with colorful decorative mat or needles. We also offer Spruce balls decorated with light and other decorative elements.

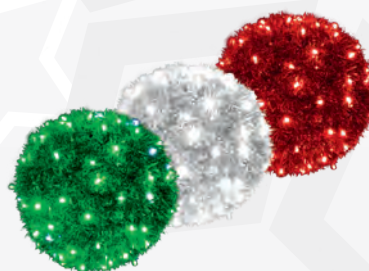

Apollo



20 cm	100 cm
25 cm	150 cm
50 cm	200 cm
80 cm	

Jeżyk / Hedgehog



30 cm	60
40 cm	92
50 cm	108

Perfekt / Perfect



100 cm	55 cm	261
120 cm	55 cm	291
150 cm	55 cm	437
160 cm	60 cm	468
250 cm	75 cm	1188



PL Na życzenie Klienta możemy przedstawić propozycję udekorowania choinek, girland, wianków i kul.

EN On individual inquiry, we can offer decoration of Christmas tree with garlands, wreaths and balls.

Ozdoby

Ornamentation

Kokardy / Bows



6 cm	25 cm
10 cm	30 cm
15 cm	40 cm
20 cm	45 cm

Bombki / Baubles

PL Bombki dostępne są w różnych kolorach.

EN Baubles are available in different colours.



35 mm	100 mm
50 mm	120 mm
60 mm	150 mm
80 mm	200 mm





www.dekoracje.campania.pl



www.decorations.campania.pl



AMR CAMPANIA

ul. Pszczyńska 190c
44-335 Jastrzębie-Zdrój
PL-POLAND

+48 32 47 40 864

Fax: +48 32 47 51 753

biuro@campania.pl



Przedstawione w niniejszym katalogu produkty i zdjęcia chronione są prawem autorskim.
Wykorzystywanie ich dozwolone jest jedynie za zgodą firmy AMR CAMPANIA.

Products and images presented in this catalogue are protected by copyright.
Using them is permitted only with the approval of AMR CAMPANIA.